

Date rev. Description

House	P1717-19 Jenny	Sheet	1
Drawing	3D	Scale	
Material	19x114	Date	26.11.2015
Drawer	K.K.	File	P1717-19 Jenny 3D.dwg

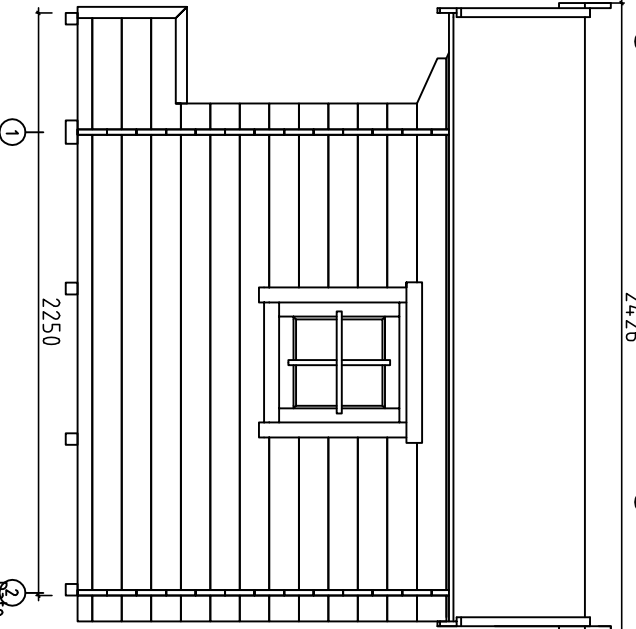
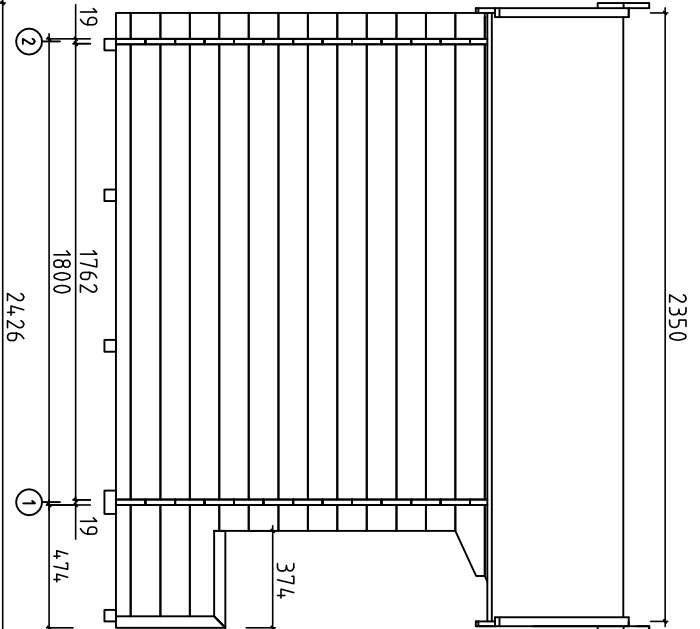
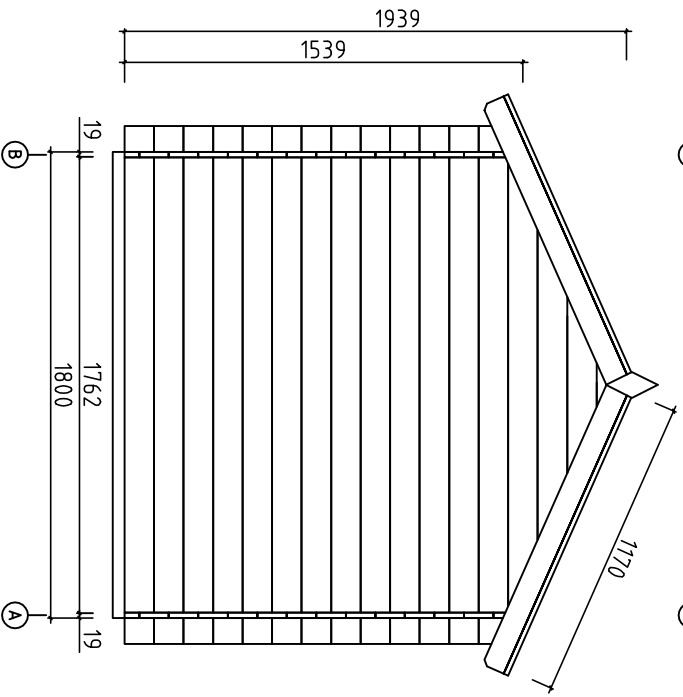
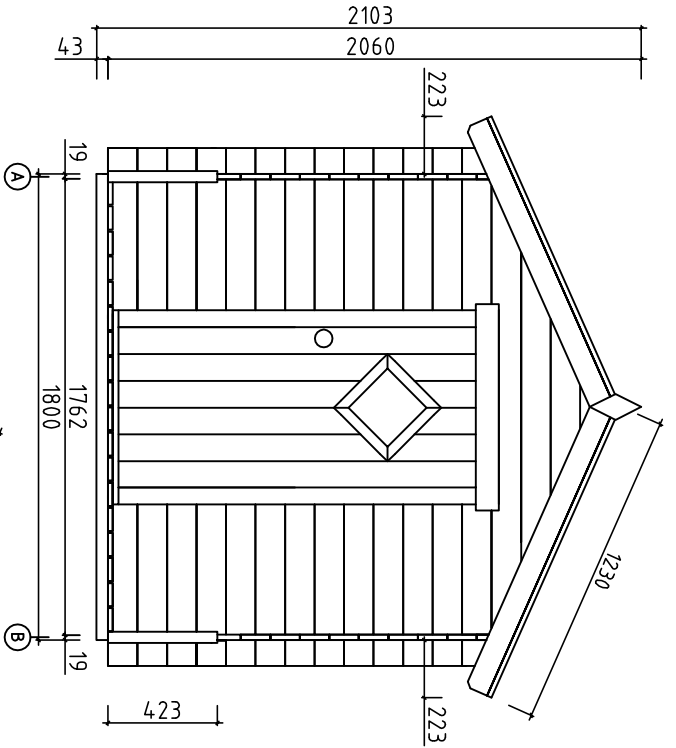

Roof Pmax=85kg/m2
V 1.0

rev. Description



House	P1717-19 Jenny	Sheet	2
Drawing	Views-kuvat-sedd	Scale	1:20
Material	19x114	Date	26.11.2015
Drawer	K.K.	File	P1717-19 Jenny Views.dwg

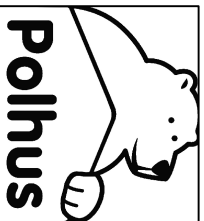
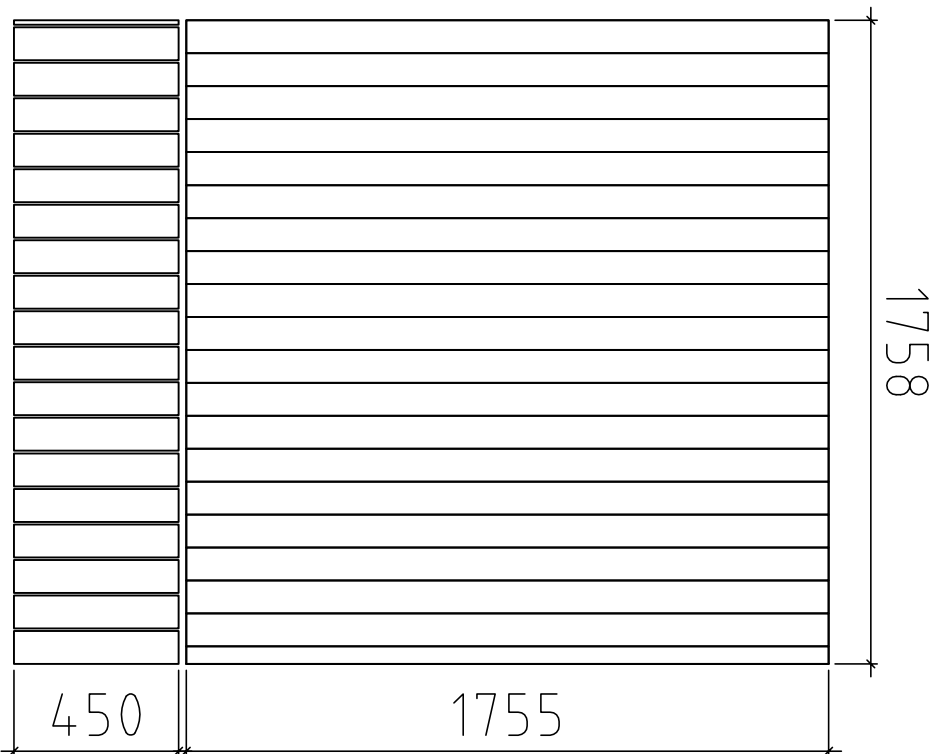
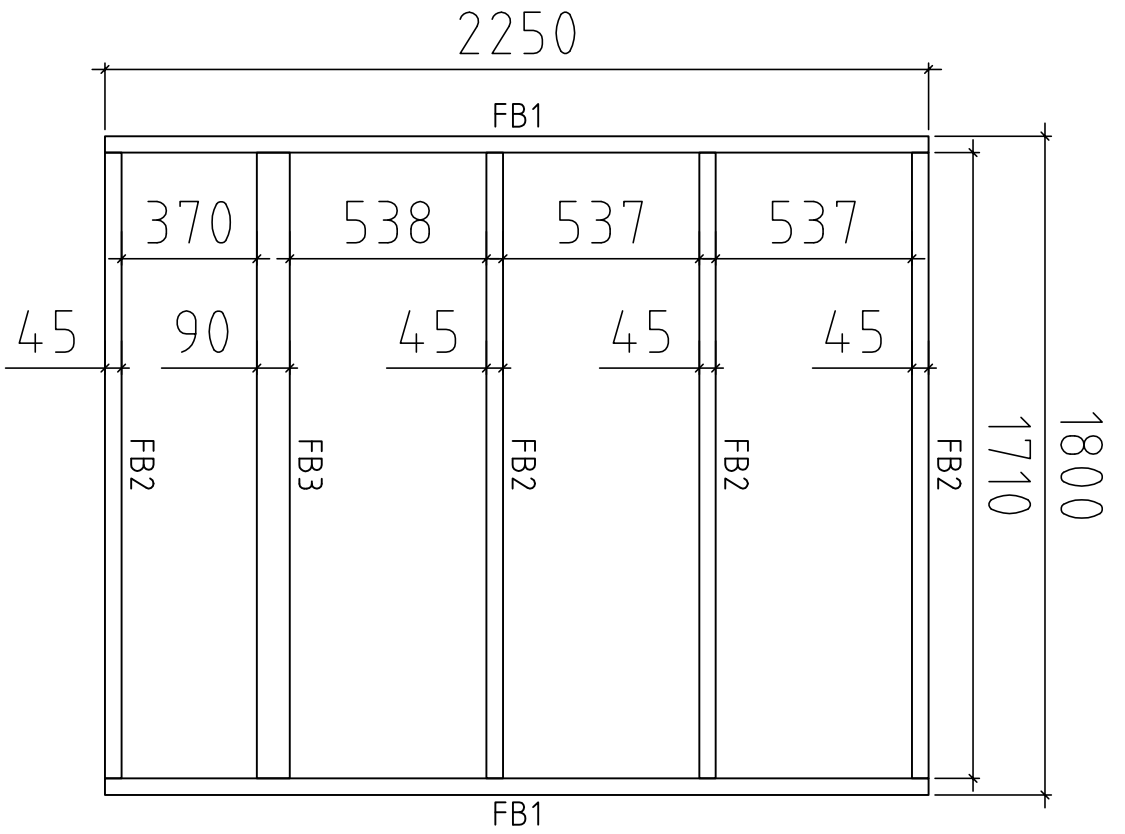

Date	rev.	Description	Sheet
		House P1717-19 Jenny	3
		Drawing Floorbeams-lattipalkit-golvbjalkar	Scale 1:20
		Material 90x45, 45x45	Date 26.11.2015
Drawer	K.K.	File	P1717-19 Jenny.dwg

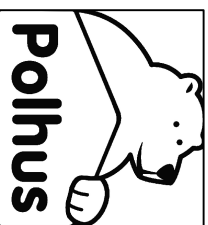
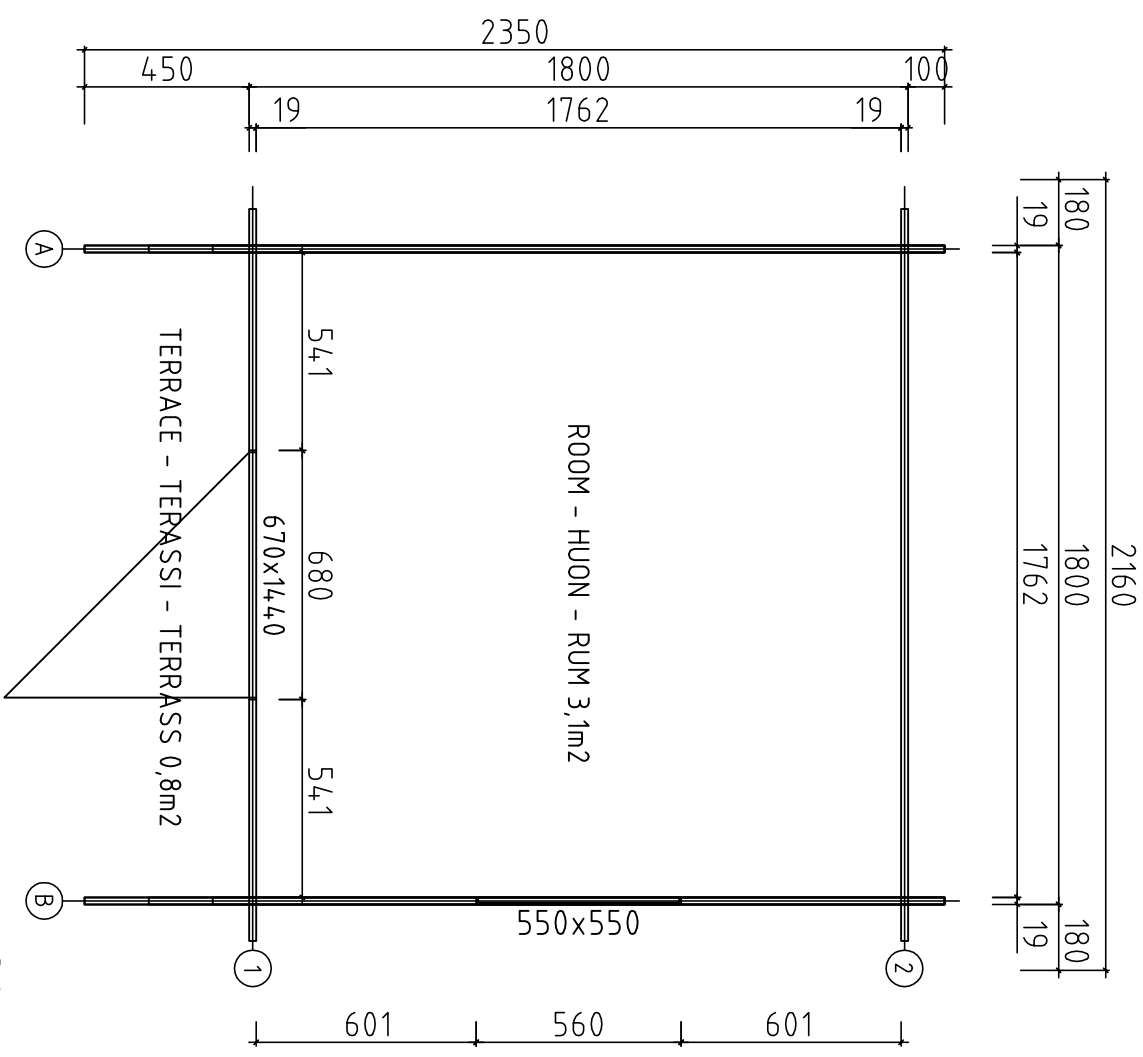

Date		rev.		Description	
House	P1717-19 Jenny	Sheet	4		
Drawing	Plan	Scale	1:20		
Material	19x114	Date	26.11.2015		
Drawer	K.K.	File	P1717-19 Jenny.dwg		

Banister U-profil
U-profil för räcket
Kaiteen U-profil 43x43x374

Banister U-profil
U-profil för räcket
Kaiteen U-profil 43x43x423

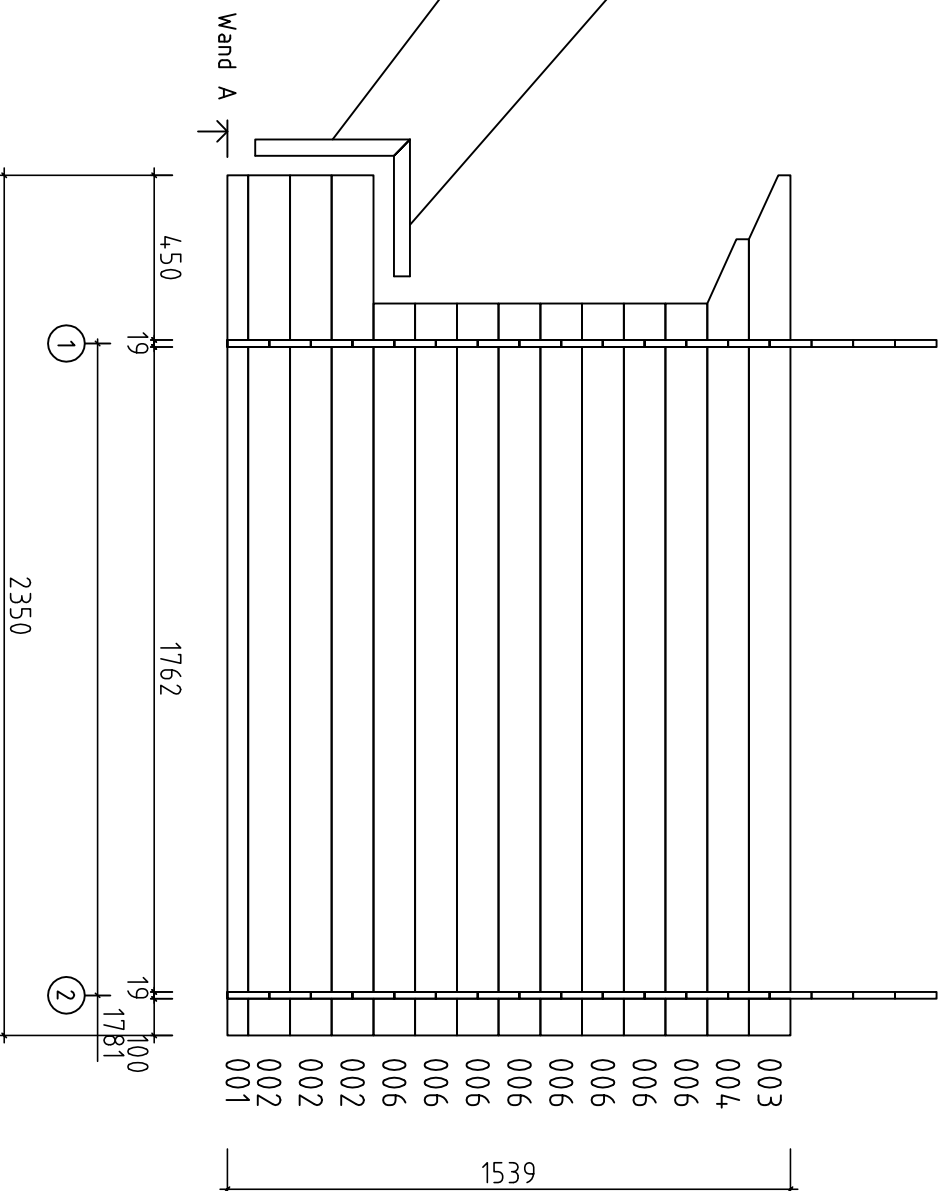

Date rev. Description

 Polhus	House	P1717-19 Jenny	Sheet	5
	Drawing	Plan	Scale	1:20
	Material	19x114	Date	26.11.2015
Drawer	K.K.	File	P1717-19 Jenny.dwg	

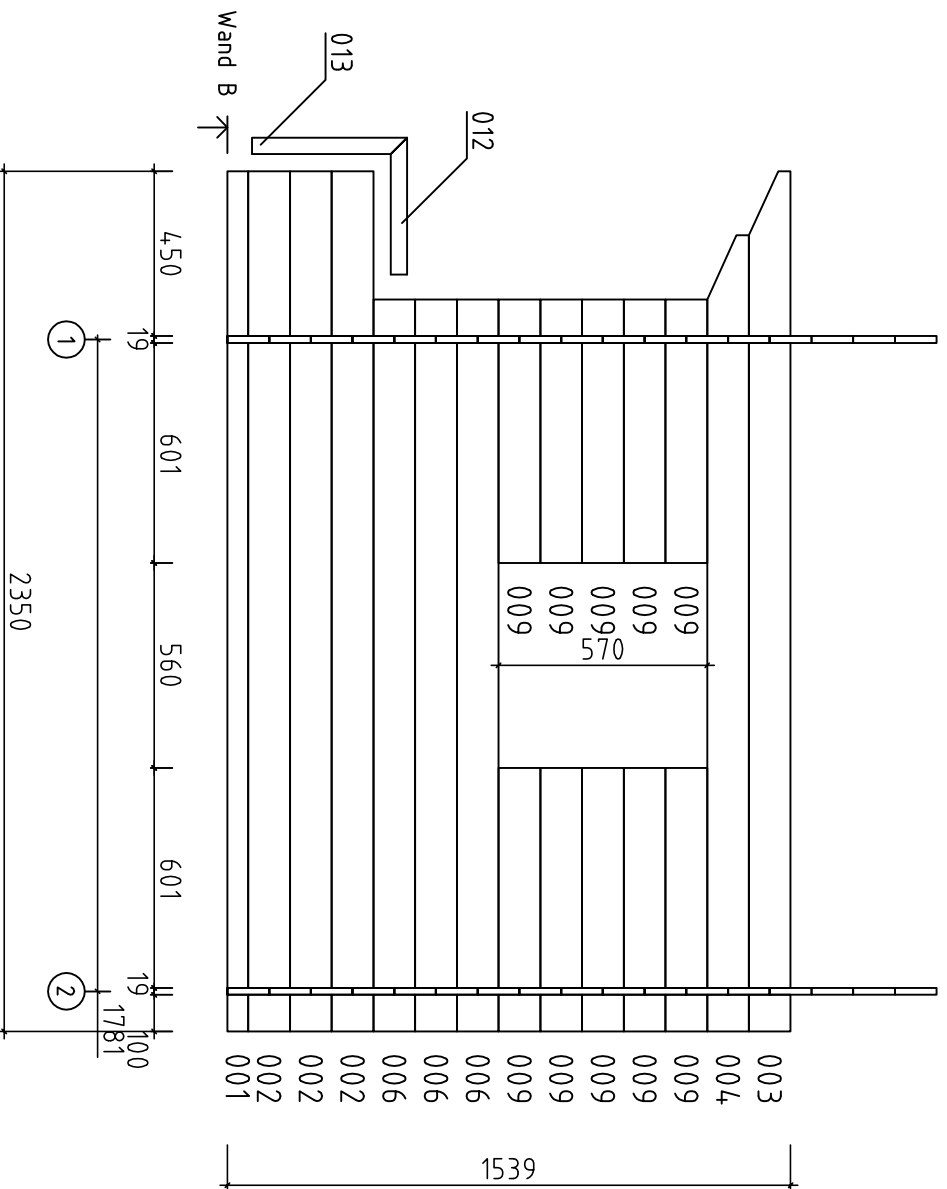

Date rev. Description

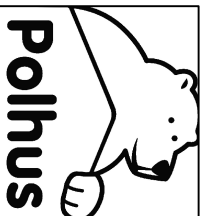

House	P1717-19 Jenny	Sheet	6
Drawing	Plan	Scale	1:20
Material	19X114	Date	26.11.2015
Drawer	K.K.	File	P1717-19 Jenny.dwg

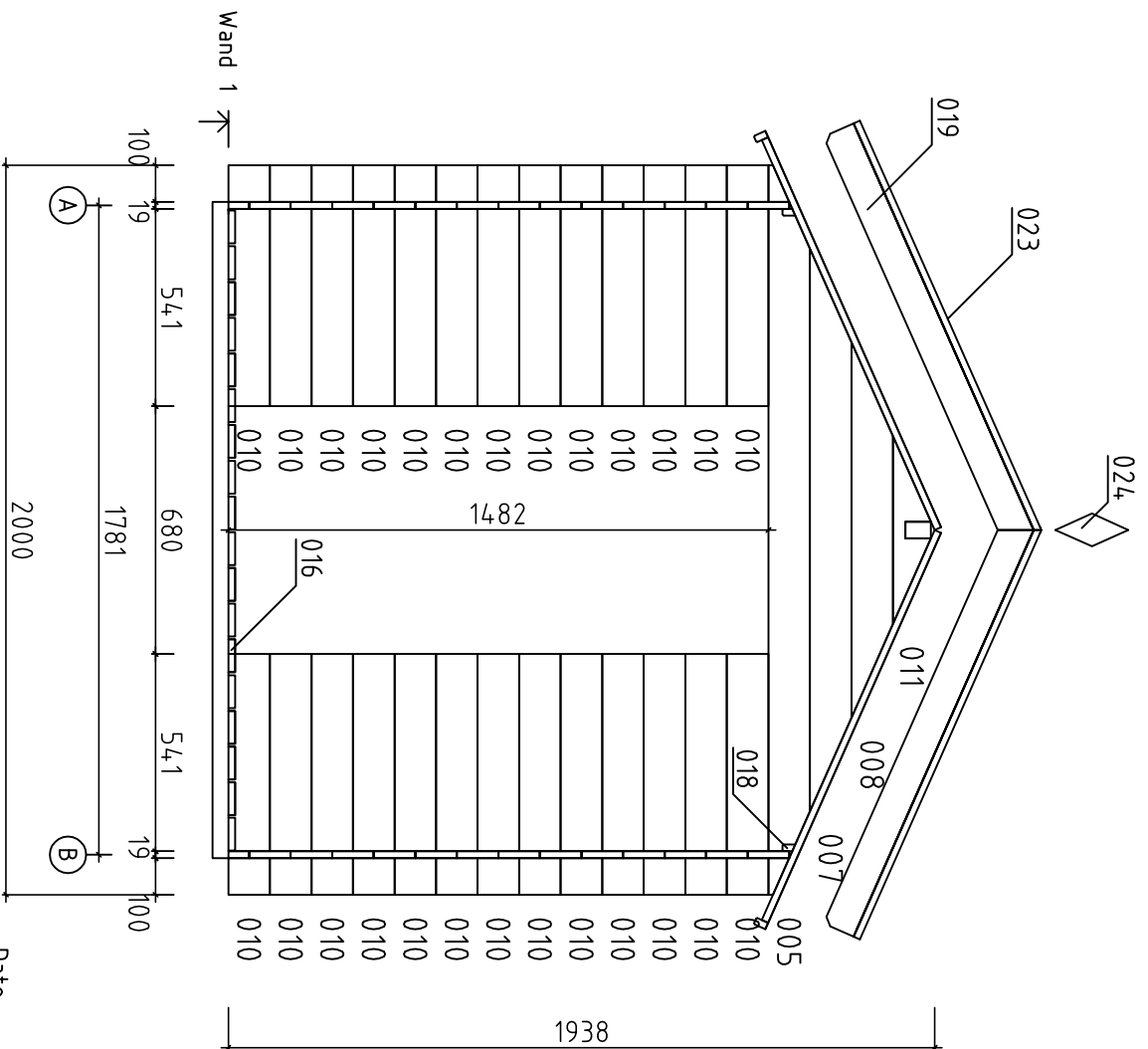

Date rev. Description

House	P1717-19 Jenny	Sheet	7
Drawing	Plan	Scale	1:20
Material	19X114	Date	26.11.2015
Drawer	K.K.	File	P1717-19 Jenny.dwg

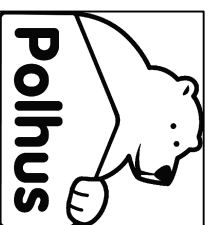

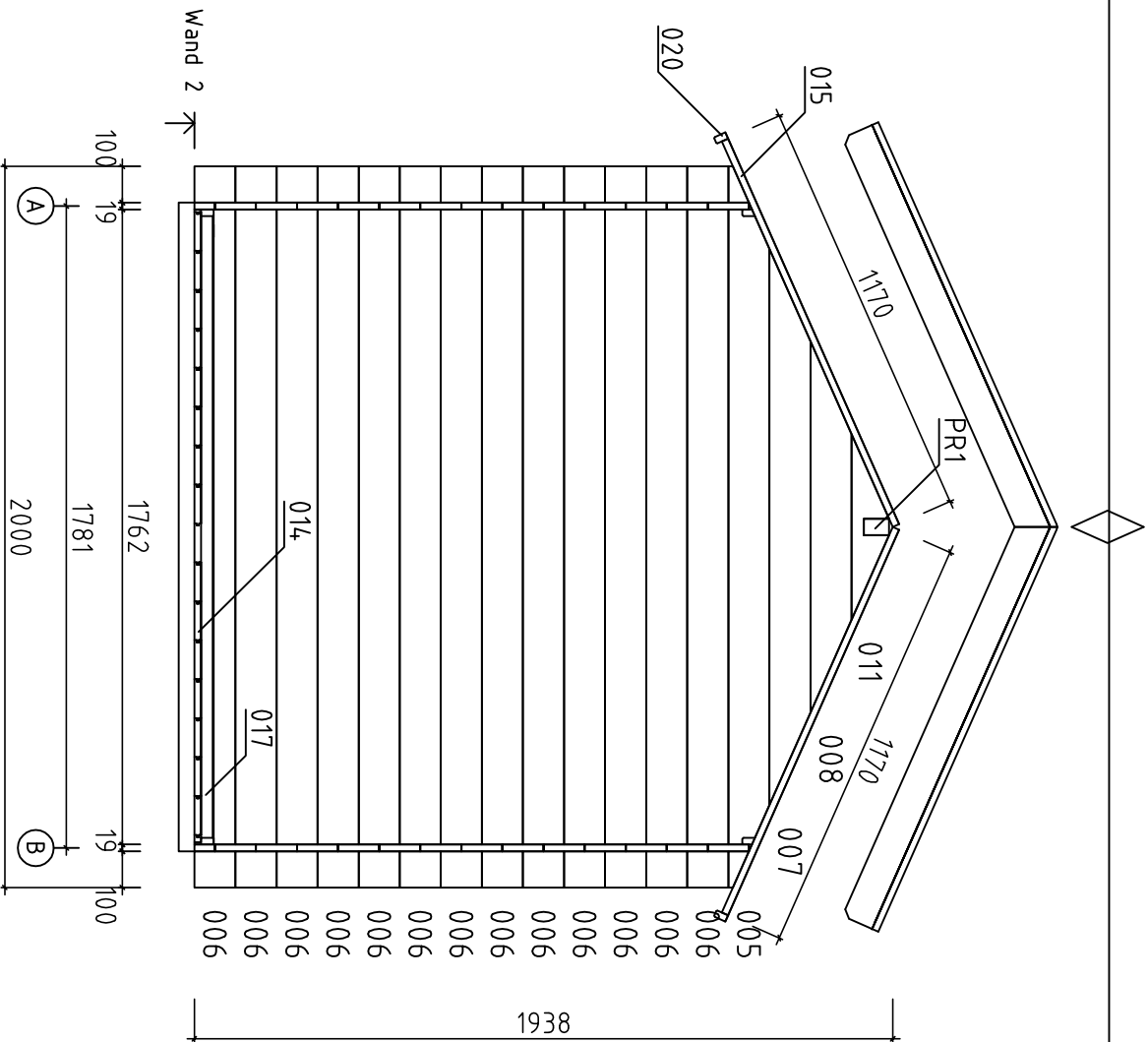

Date rev. Description



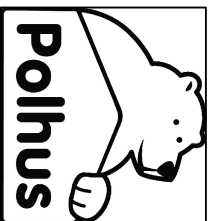







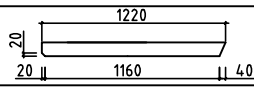

House	P1717-19 Jenny	Sheet	8
Drawing	Plan	Scale	1:20
Material	19X114	Date	26.11.2015
Drawer	K.K.	File	P1717-19 Jenny.dwg

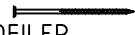

PAKK L<2.35m

Pos	P1717-19 Jenny	Pcs.	Profil (mm)	L (mm)		
001		2	19x57	2350		
002		6	19x114	2350		
003		2	19x114	2350		
004		2	19x114	2175		
005		2	19x114	2000		
006		+1= EXTRA PROFILE	24+1	19x114	2000	
007		2	19x114	1543		
008		2	19x114	1029		
009		10	19x114	720		
010		26	19x114	660		
011		2	19x104	514		
M	BOARD FOR ASSEMBLING - ASENNUSLAUTA - SLAGBRÄDE	2	19x114	300		
W1-1		1	19x4,4,6	2000		
W2-1		1	19x4,4,6	2000		
FB3	FLOORBEAMS-LATTIAPALKIT-GOLVBJÄLKAR	1	90x45	1710		
FB1	FLOORBEAMS-LATTIAPALKIT-GOLVBJÄLKAR	2	45x45	2250		
FB2	FLOORBEAMS-LATTIAPALKIT-GOLVBJÄLKAR	4	45x45	1710		
012	BANISTER U-PROFILE-KAITEEN U-PROFILI-U-PROFIL FOR RÄCKET	2	43x43	374		
013	BANISTER U-PROFILE-KAITEEN U-PROFILI-U-PROFIL FOR RÄCKET	2	43x43	423		
RB1	PURLIN-KATTO-ORRET-TAKBJÄLKAR	1	45x90	2350		
014	FLOORBOARD-LATTIALAUTA-GOLVBRÄDE	16+1 20+1	114x19 88x19	1755 1755		
015	ROOFBOARD-KATTOLAUTA-TAKBRÄDE	4+2+1 5+4+1	114x19 88x19	1170 1170		
016	TERRACE BOARD-TERASSILAUTA-TERRASBRÄDE	19+1 15+1	90x19 120x19	450		
Kood	P1717-19 Jenny	Materjal	File	P1717-19 Jenny.dwg	Leht	9

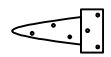
PAKK L<2.35m

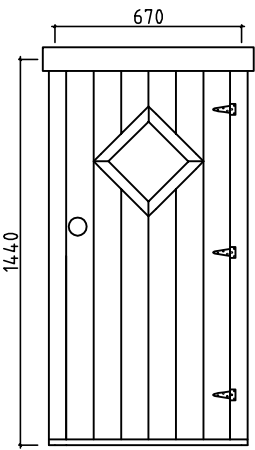
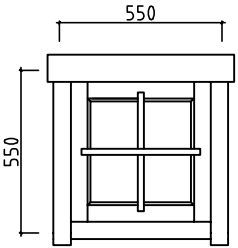
Pos	P1717-19 Jenny	Pcs.	Profil (mm)	L (mm)		
017	SKIRTING SLAT-LATTIALISTA-GOLVLIST 		19x35	7m		
018	SIDEWALL SKIRTING SLAT-SIVUSEINÄ LISTA-SIDOVÄGG LIST 	2 2 2	19x35 19x35 19x35	1762 450 100		
019	GABLE BOARD-KAAPELILAUTA-GAVELBRÄDA 	4	19x90	1220		
020	EAVE SLAT-RÄYSTÄSLISTA-TAKFOTSLIST 	2	19x35	2350		
023	BOARD MATCHING GABLE BOARD-KAAPELILAUDAN PEITELAUTA GAVELBRÄDA FÖR VINDBRÄDE 	4	19x35	1230		
024	DECORATIVE PIECE-PRYDNADSSTYCKE-KORISTEKAPPALE 	2	19x90	200		
025	NAILS-NAULAT-SPIKAR FOR FLOOR & ROOF-KATTO & LATTIA-GOLV & TAK 	290	φ2.5	60		
026	NAILS-NAULAT-SPIKAR FOR FLOOR & EAVESLAT-LATTIA & RÄYSTÄSLISTA-GOLV&TAKFOTSLIST 	42	φ2.0	4.0		
027	SCREWS-RUUVIT-SKRUVAR SIDEWALL SKIRTING SLAT, TERRACE U-PROFILE FOR EAVE AND GABLE, TERRACE BORDER BOARDS 	60	φ3.5	35		
028	SCREWS-RUUVIT-SKRUVAR FOR FIXING HALF BEAMS -KIINNITYS PUOLIKKAAT PALKIT - FÖR ATT FÄSTA HALVA VÄGGPROFILER 	10	φ4.5	90		
029	WINDOW HANDLE-IKKUNA KAHVA-FÖNSTER HANDTAG 	1				
030	DOOR KNOB-OVEN PAINIKE-DÖRR HANDTAG 	1				
031	DOOR HINGES-OVEN SARANAT-DÖRR GÅNGJÄRN 	3				
032	WINDOW CROSSES-IKKUNARISTIKKO-SPRÖJS 	1				
031	DOOR-OVI-DÖRR 670x1440 1pc-kpl-st (Right hand-oikea käsi-höger hand) 	1	670	1440		
032	WINDOW-IKKUNA-FÖNSTER 550x550 1pc-kpl-st (Left hand-vasen käsi-vänster hand) 	1	550	550		
Kood	P1717-19 Jenny	Materjal	File	P1717-19 Jenny.dwg	Leht	10

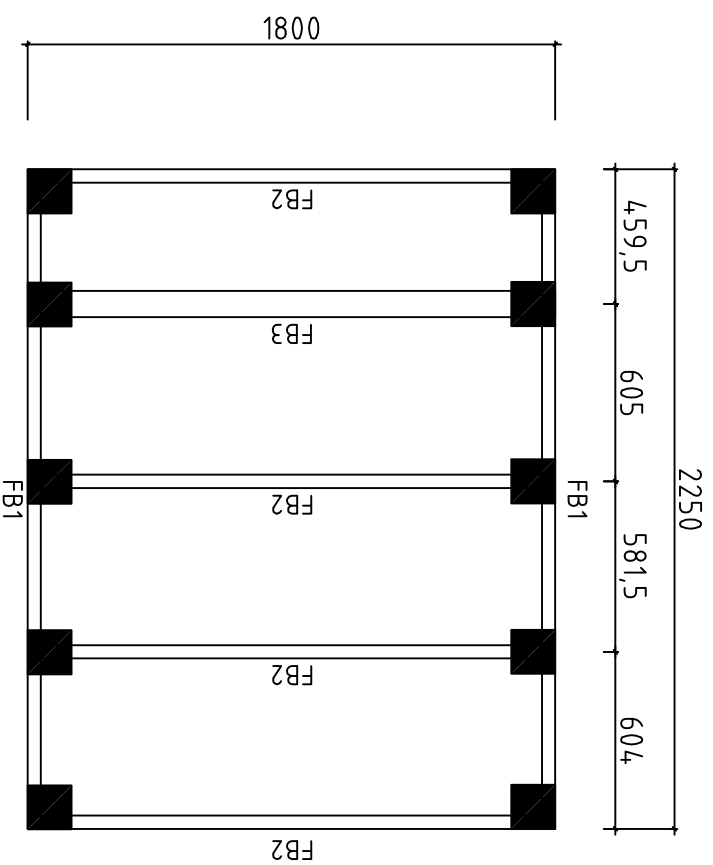

Detta är ett förslag för hur man kan placera plintarna (100- 200 mm i diameter) för golvbjälklaget. Golvbjälkarna är med i byggsatsen, men inte plintarna. Använder man exempelvis 500-600mm långa murblock så kan man halvera antalet punkter. Lägg fuktskyddande papp mellan betong och trä

Tämna on ehdotus siitä, miten (100-200 mm läpimitäiset) jalat voidaan sijoittaa alapohjan varten. Lattiapalkit ovat rakennussarjassa, mutta jalkoja ei ole. Kun käytetään esimerkiksi 500-600 mm pitkiä harkkoja, voidaan pisteiden määrä puolitaa. Aseta betonin ja puun väliin kosteudelta suojavaa pappi

A proposal for placing plinths (100-200 mm in diameter) for floor beams. Floor beams are provided in the kit but plinths are not included. For example, by using 500-600 mm long masonry units, one can reduce the number of points 50%. Place cardboard between the concrete and wood to protect from moisture

Date rev. Description

House	Sheet
P1717-19 Jenny	11
Drawing	Scale
FOUNDATION PLAN - PLINTPLAN	1:25
Material	Date
	26.11.2015
Drawer	File
KK	F91717-19 Jenny.dwg