

Date rev. Description

V 1.0

House	S4020-90 Folkbastun	Sheet	1
-------	---------------------	-------	---

Drawing	3D	Scale	
---------	----	-------	--

Material	90x160	Date	09.11.2018
----------	--------	------	------------

Drawer	K.K.	File	S4020-90 Folkbastun 3D.dwg
--------	------	------	----------------------------

Views and ground plan - Fasader och grundplan - Julkisivut ja pohjapiirustus

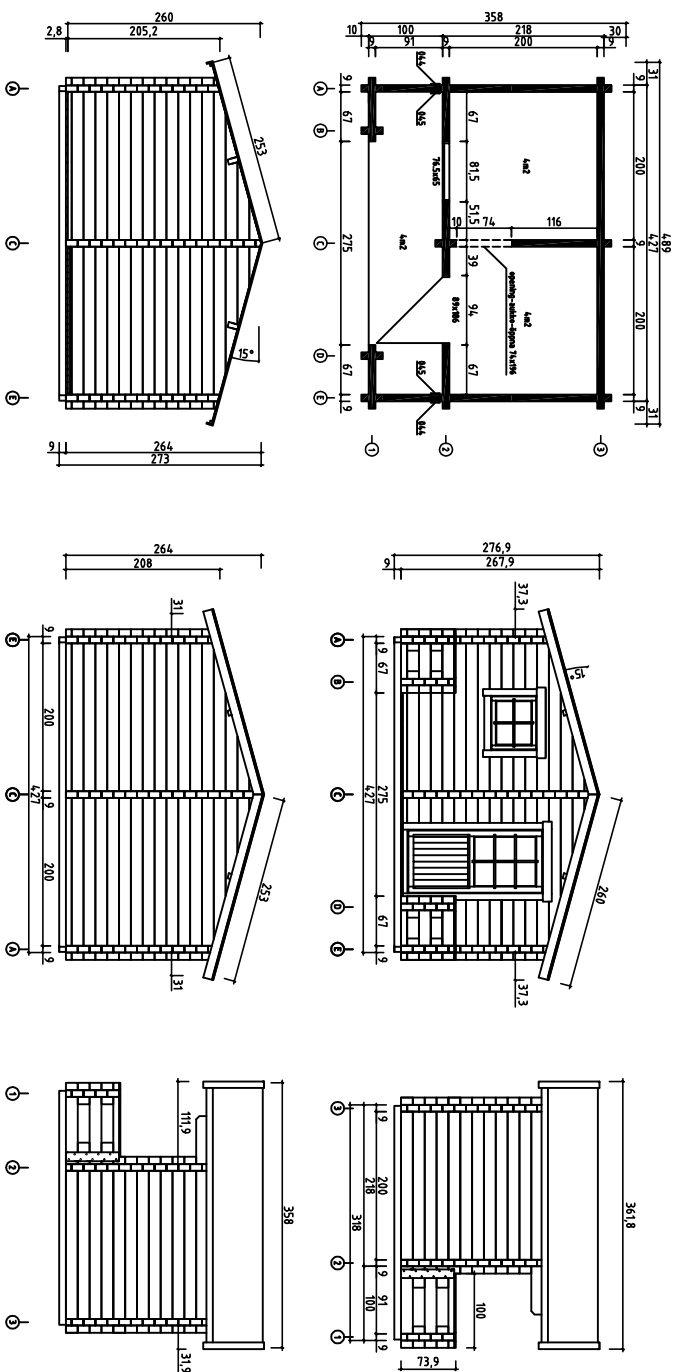

Roof Pmax=240kg/m²
V 1,0

Date rev. Description

House	S4020-90 Folkbastun	Sheet	1
Drawing		Scale	1:100
Material	90x160	Date	09.11.2018
Drawer		File	S4020-90 Folkbastun Views.dwg

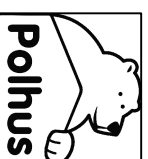

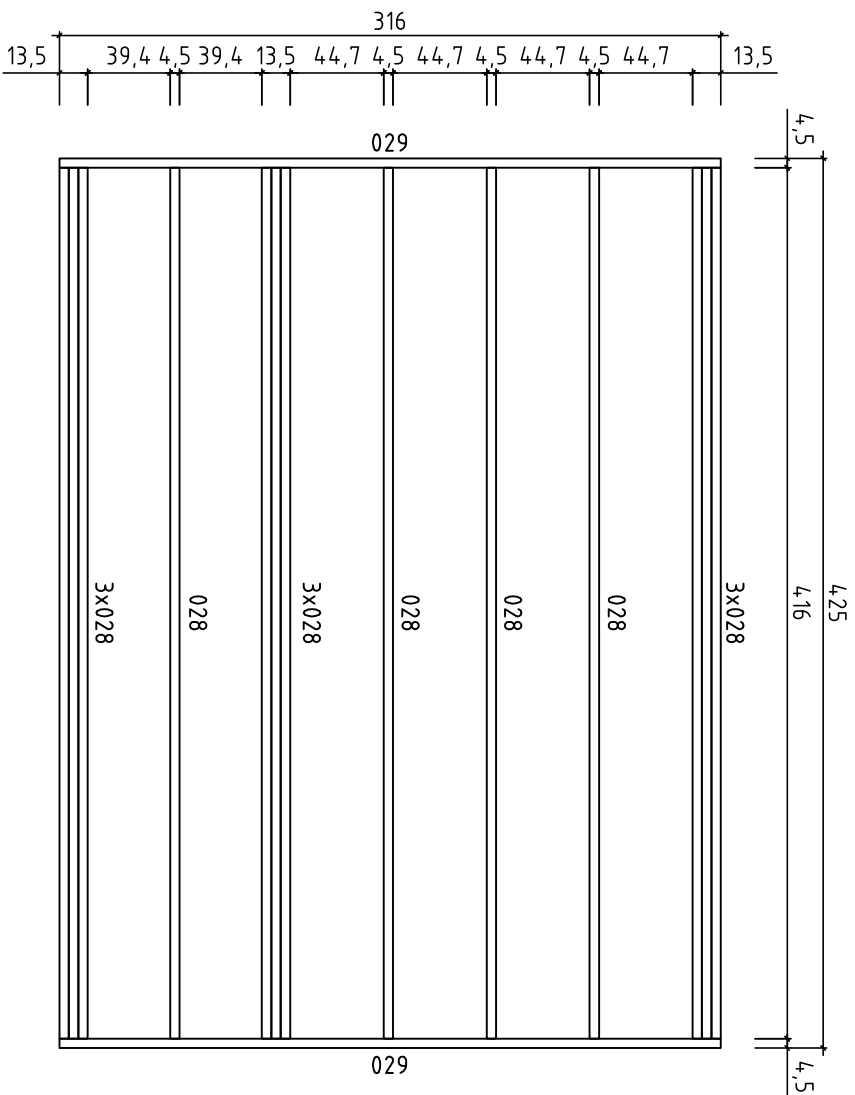

Date rev. Description

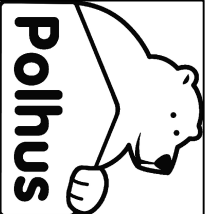

House	S4020-90 Folkbastun	Sheet	2
Drawing	Floorbeams-lattipalkit-golvjälkar	Scale	1:35
Material	45x90	Date	09.11.2018
Drawer	K.K.	File	S4020-90 Folkbastun Floorbeams.dwg

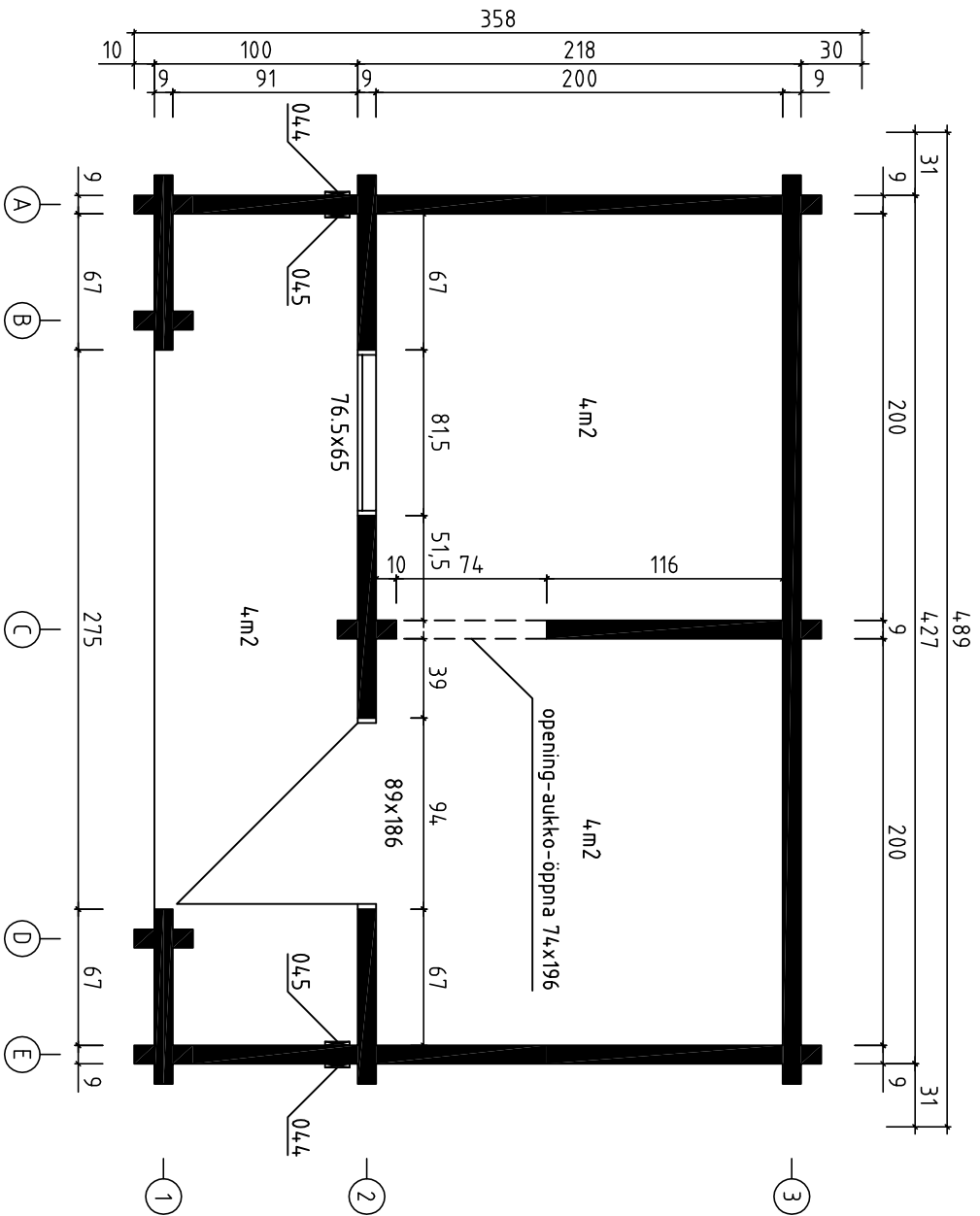

Date rev. Description

House	S4020-90 Folkbastun	Sheet	3
Drawing	Plan	Scale	1:35
Material	90x160	Date	14.11.2016
Drawer	File S4020-90 Folkbastun Plan.dwg		

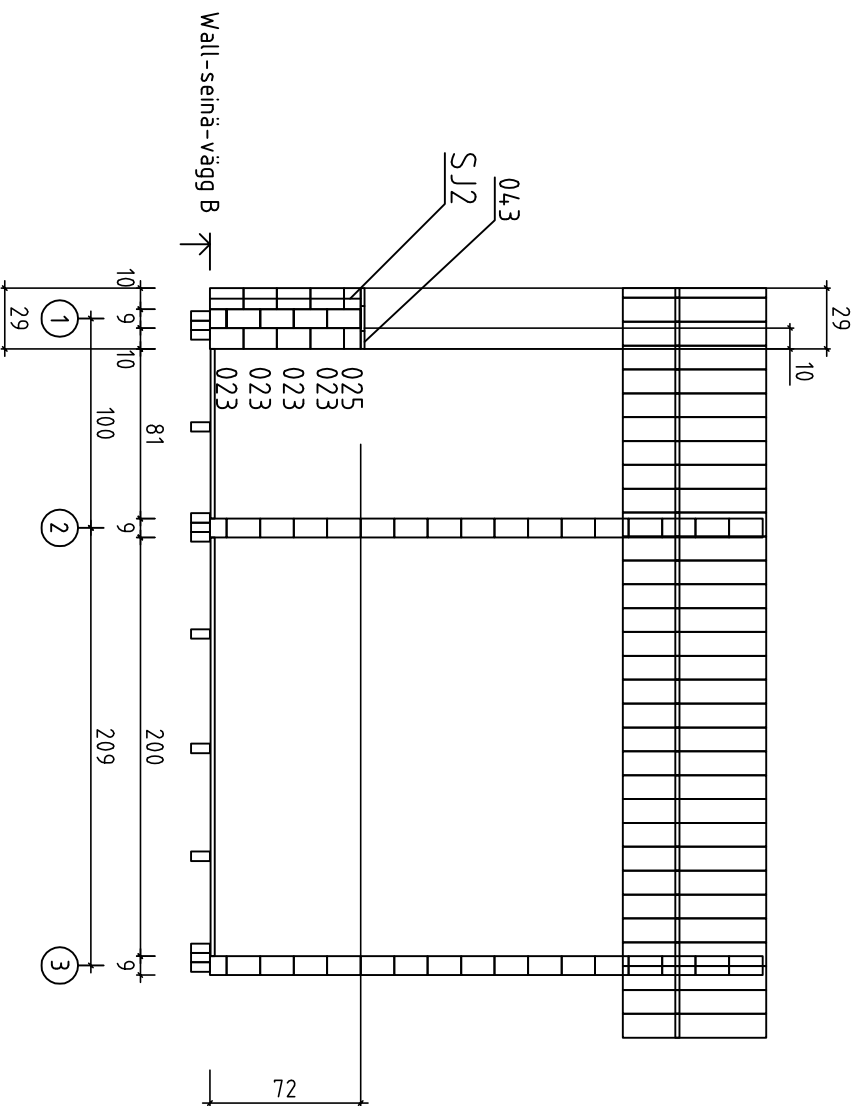

Date rev. Description

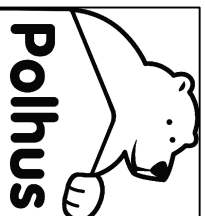

House	S4020-90 Folkbastun	Sheet	5
Drawing	Wall-seinä-vägg B	Scale	1:35
Material	90x160	Date	09.11.2018
Drawer		File	S4020-90 Folkbastun.dwg

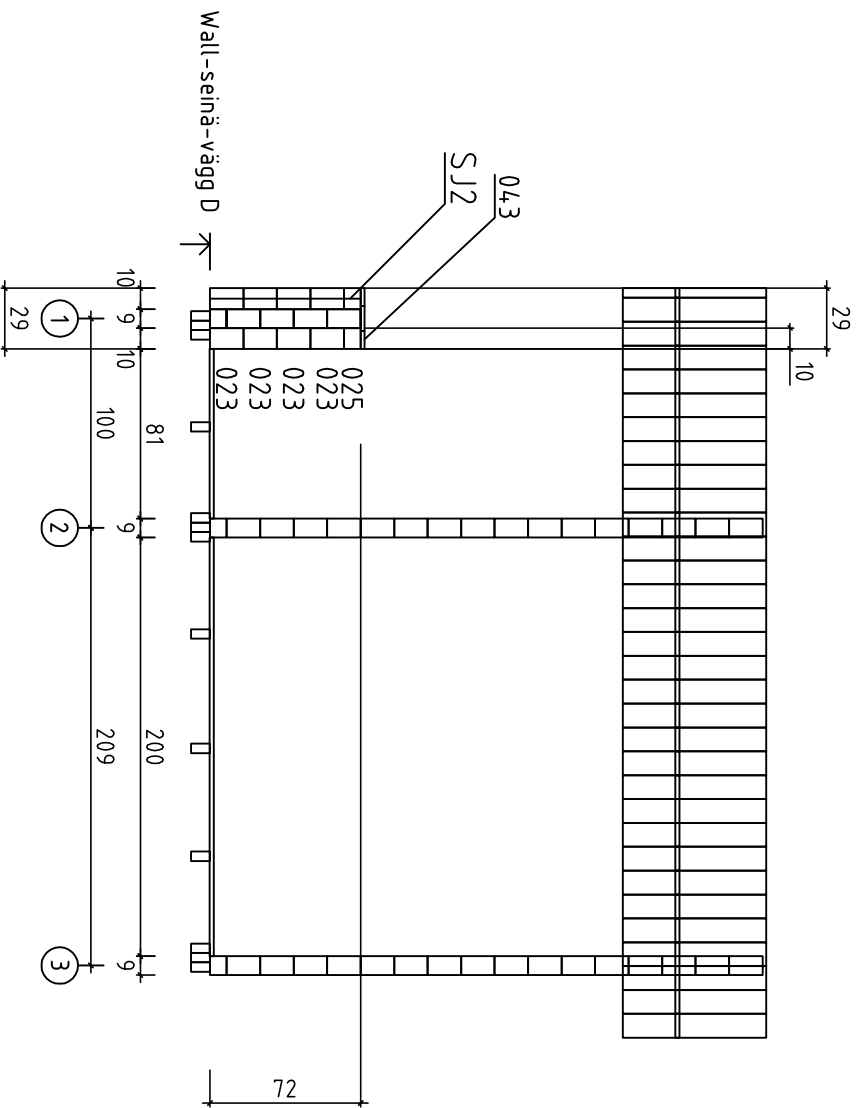

Date rev. Description

			
House	S4020-90 Folkbastun	Sheet	7
Drawing	Wall-seinä-vägg D	Scale	1:35
Material	90x160	Date	09.11.2018
Drawer		File	S4020-90 Folkbastun.dwg

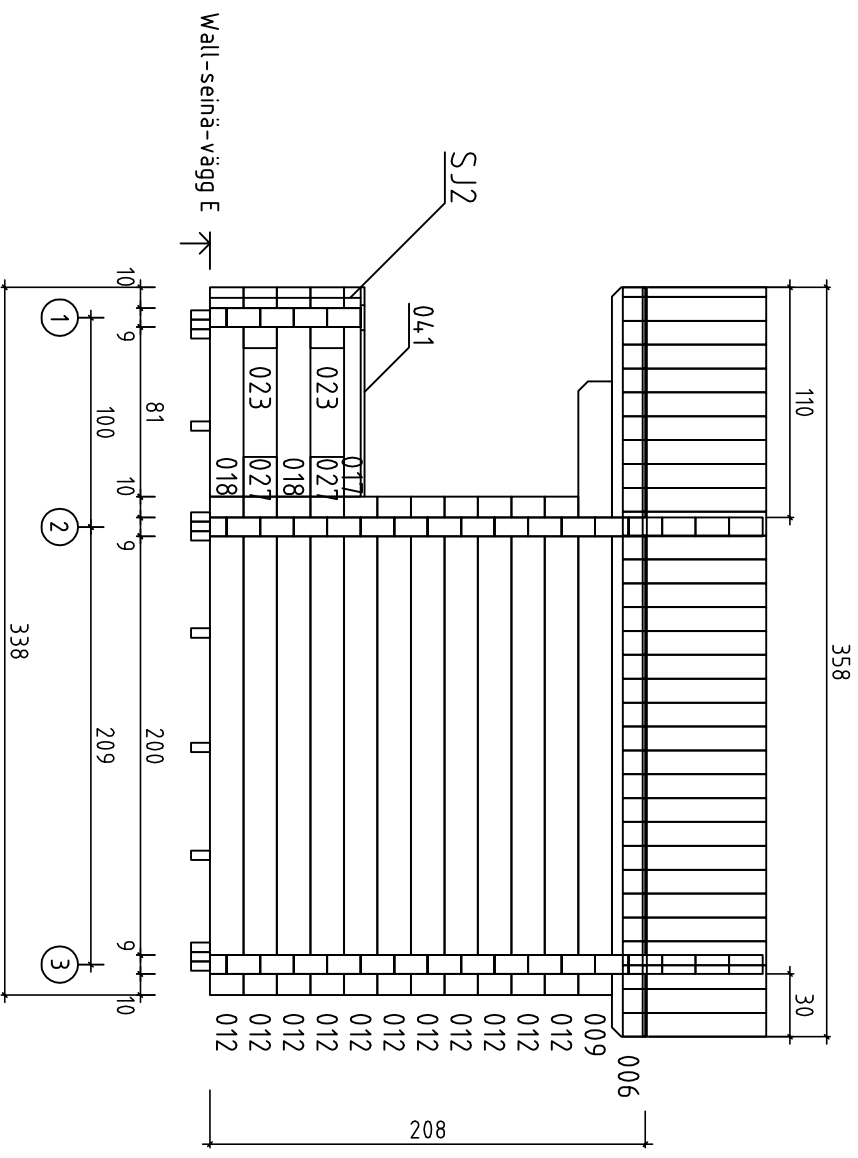

Date rev. Description

 Polhus		House	S4020-90 Folkbastun	Sheet	8
		Drawing	Wall-seinä-vägg E	Scale	1:35
Material	90x160	Date	09.11.2018		
Drawer	File		S4020-90 Folkbastun.dwg		

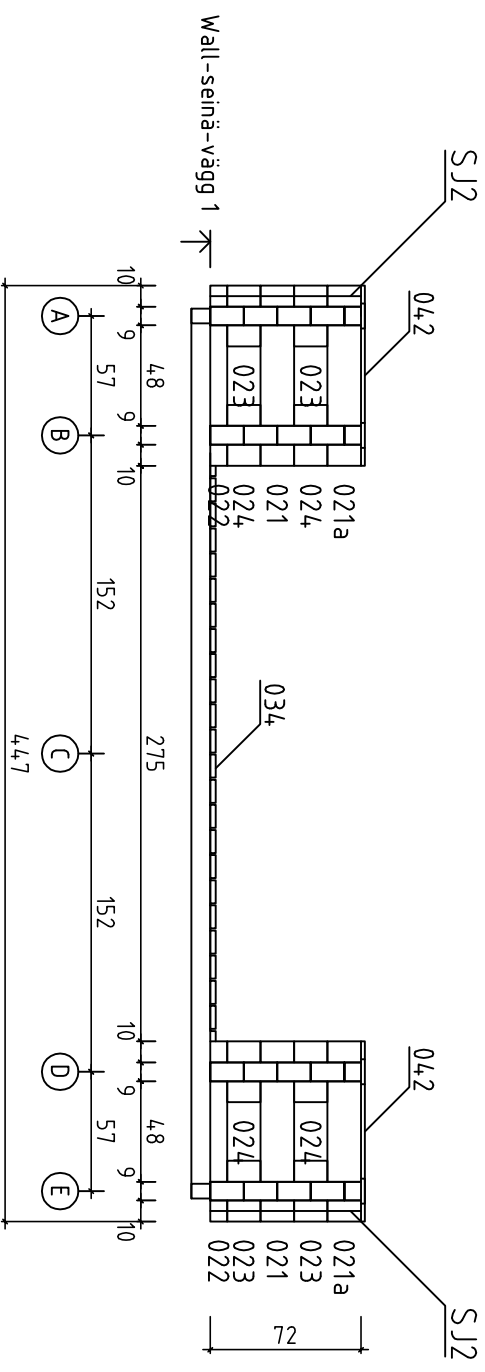
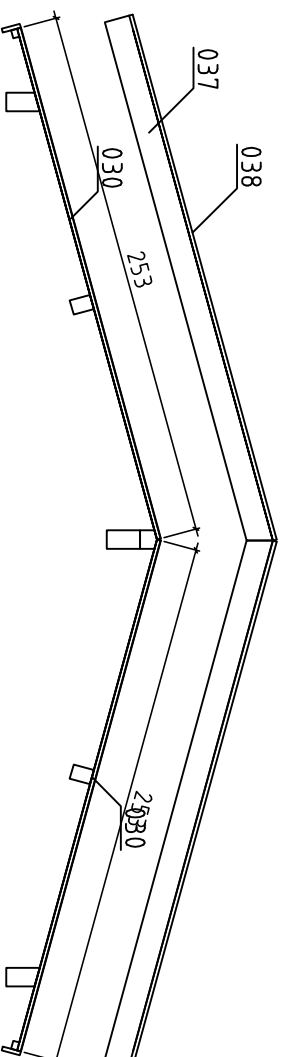

Date rev. Description



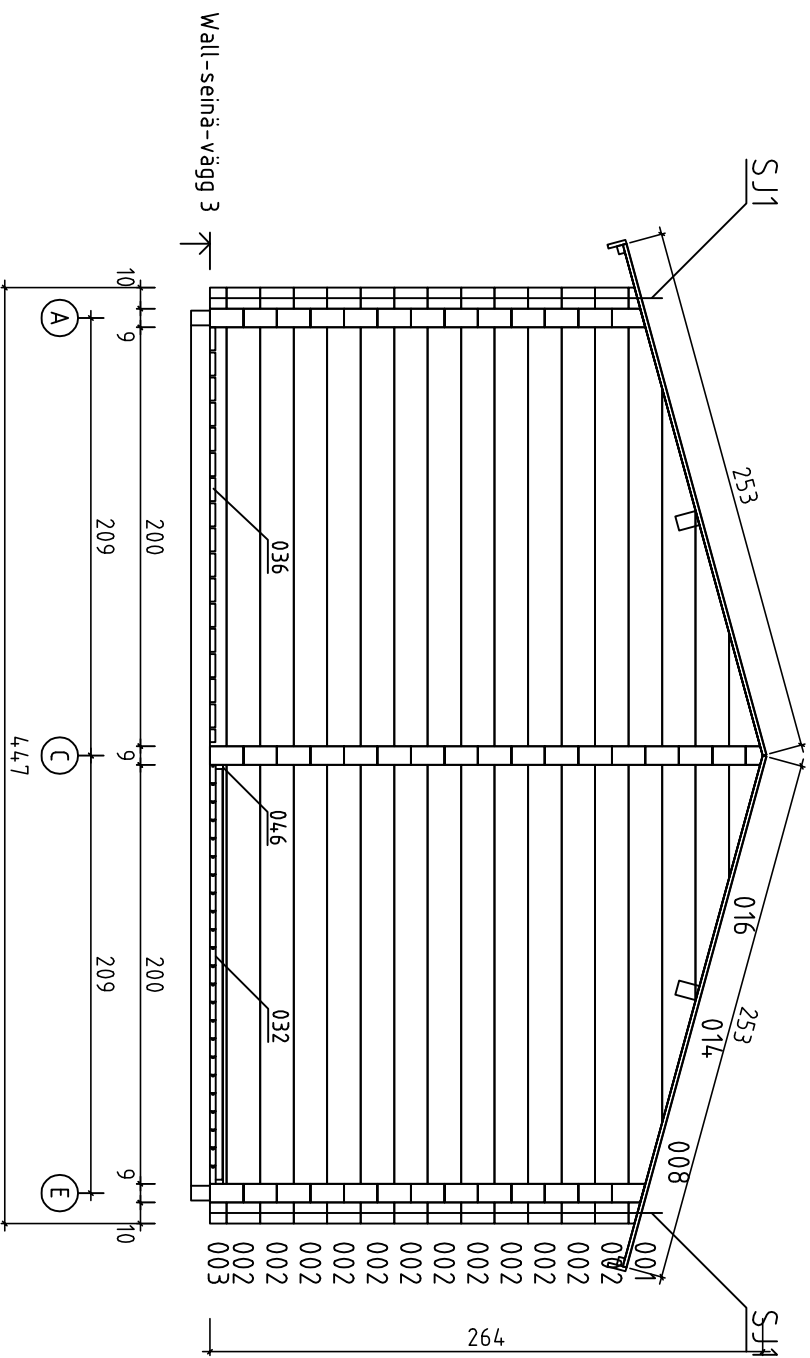









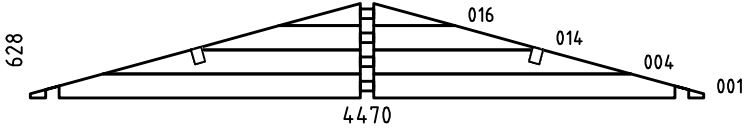
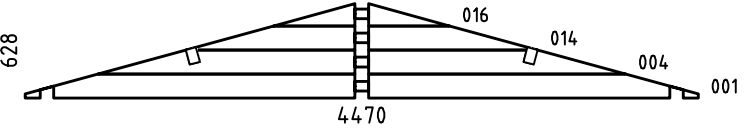
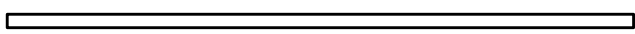
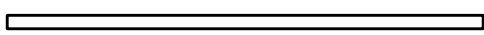
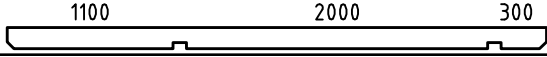

			
House	S4020-90 Folkbastun	Sheet	9
Drawing	Wall-seinä-vägg 1	Scale	1:35
Material	90x160	Date	09.11.2018
Drawer	File S4020-90 Folkbastun.dwg		





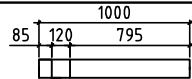
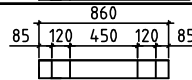







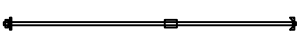

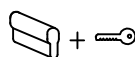

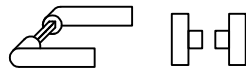

Date rev. Description

 Polhus		House	S4020-90 Folkbastun	Sheet	11
		Drawing	Wall-seinä-vägg 3	Scale	1:35
Material	90x160	Date	09.11.2018		
Drawer				File	S4020-90 Folkbastun.dwg

Pos	S4020-90 Folkbastun	Pcs.	Profile (mm)	L (mm)
001		2	90x160	4470
002		12+1	90x160	4470
003		2	90x80	4470
004		1	90x160	3580
005		1	90x160	3580
006		1	90x160	3580
007		1	90x80	3580
008		2	90x160	3506
009		2	90x160	2930
010		7	90x160	2670
011		1	90x160	2670
012		24	90x160	2380
013		1	90x160	2380
014		2	90x160	2337
015		12	90x160	1350
016		2	90x148	1169
017		2	90x80	1000
018		4	90x160	1000
019		4	90x160	995
020		16	90x160	860
021		2	90x160	860
021a		2	90x160	860
022		2	90x80	860
023		16	90x160	290
024		4	90x160	290

Pos	S4020-90 Folkbastun	Pcs.	Profile (mm)	L (mm)	
025	100100 	2	90x80	290	
026	100100 	12	90x160	290	
027		4	90x160	190	
W2-1		1	90x628	4470	
W3-1		1	90x628	4470	
028	FLOORBEAMS-LATTIAPALKIT-GOLVBJÄLKAR 	IMM	13	45x90	4160
029	FLOORBEAMS-LATTIAPALKIT-GOLVBJÄLKAR 	IMM	2	45x90	3160
030	PURLINS-KATTO ORRET-TÅKASAR 1100 2000 300 	2	70x140	3580	
031	ROOFBOARDS-KATTOLAUTA-TAKBRÄDE  88mm or-tai-eller 114mm	82+1 64+1	18x88 18x114	2530 2530	
032	FLOORBOARDS-LATTIALAUTA-GOLVBRÄDE  88mm or-tai-eller 114mm	23+1 18+1	18x88 18x114	1990 1990	
034 035	TERRACE BOARDS-TERASSILAUTA-TERASSBRÄDE 	IMM	22+1 11	28x120 990 900	
036	SAUNA BOARDS-SAUNA LATTIALAUTA-SAUNA GOLVBRÄDE 	17+1	28x120	1990	
037	GABLE BOARDS-KAAPILAUTA-GAVELBRÄDA 	4	18x120	2600	
038	BOARD MATCHING WITH GABLE BOARD - KAAPILAUTA VASTAVA LAUTA - BRÄDE OVANPÅ GAVELBRÄDE 	4	18x90	2600	
039	EAVE BOARD-RÄYSTÄSLAUTA-TAKFOTBRÄDE 	2	18x90	3580	
040	EAVE SLAT-RÄYSTÄSLISTA-TAKFOTLIST 	2	30x40	3580	
041	TERRACE BORDER BOARD - TERASSI REUNALAUTA - TERASSFODERBRÄDE 	2	18x120	1000	
042	TERRACE BORDER BOARD - TERASSI REUNALAUTA - TERASSFODERBRÄDE 	2	18x120	860	
043	TERRACE BORDER BOARD - TERASSI REUNALAUTA - TERASSFODERBRÄDE 	2	18x120	290	
044 045	TERRACE CONNECTING BOARDS-TERASSI KIINITYSLAUTA-BRÄDE FÖR ATT FASTA TERASS 	2 2	18x120 18x120	720 692	
046	SKIRTING SLAT-LATTIALISTA-GOLVLIST 		18x35	8.5m	
047 048	TENON BOARD-TAPPILAUTA-TAPBRÄDE 	2 2	18x90 18x90	1920 1860	
Kood S4020-90 Folkbastun Materjal File S4020-90 Folkbastun.dwg Leht 13					

Pos	S4020-90 Folkbastun		Pcs.	Profile (mm)	L (mm)	
049	TENON BOARD-TAPPILAUTA-TAPBRÄDE		2	19x90	650	
050	TENON SLAT-TAPPILISTA-TAPLIST		2	19x25	1920	
051			2	19x25	1860	
052	TENON BOARD-TAPPILISTA-TAPLIST		2	19x25	650	
053	SCREW JOINT-KIERRETANKO-MYRSKYVARMISTUS-GÄNSTAPP-STORMSÄKRING		4	ØM10	2080	
054	SCREW JOINT-KIERRETANKO-MYRSKYVARMISTUS-GÄNSTAPP-STORMSÄKRING		6	ØM10	750	
055	ASSEMBLING BEAMS - ASENNUSPALKI-SLAGBRÄDE		4	90x160	250-400	
056	DOOR LOCK+KEYS/OVENLUKKO+AVAIN/DÖRRLÅS+NYCKLAR		1+1			
057	DOOR HINGES-OVEN SARANAT-DÖRR GÅNGJÄRN		6			
058	DOOR CROSSES/OVENLISTAT/SPRÖJS		1			
059	WINDOW CROSSES/IKKUNALISTAT/SPRÖJS		1			
060	DOOR HANDLE/OVEN KAHVA/DÖRR HANDTAG		1+1			
061	WINDOW HANDLE/IKKUNA KAHVA/FÖNSTER HANDTAG		1			
062	NAILS - NAULAT - SPIKAR		ROOFBOARDS-KATTOLAUTA-TAKBRÄDE FLOORBOARDS-LATTIALAUTA-GOLVBRÄDE	340	2.5	60
063	NAILS - NAULAT - SPIKAR		SKIRTING SLAT-LATTIALISTA-GOLVLIST	10	2.0	40
064	SCREWS - RUUVIT - SKRUVAR		FLOORBEAMS-LATTIAPALKIT-GOLVBJÄLKAR HALFBEAMS-PUOLEKSIPALKIT-HALVBJÄLKAR	50	4.5	90
065	SCREWS - RUUVIT - SKRUVAR		TERRACE BOARDS-TERASSILAUTA-TERASSBRÄDE SAUNA BOARDS-SAUNA LATTIALAUTA-SAUNA GOLVBRÄDE	355	4.5	70
066	SCREWS - RUUVIT - SKRUVAR		GABLE BOARDS-KAAPTELILAUTA-GAVELBRÄDA EAVE BOARD-RÄYSTÄSLAUTA-TAKFOTBRÄDE EAVE SLAT-RÄYSTÄSLISTA-TAKFOTLIST TERRACE CONNECTING BOARDS-TERASSI KIINITYSLAUTA-BRÄDE FÖR ATT FASTA TERASS	92	4.5	50
067	SCREWS - RUUVIT - SKRUVAR		TERRACE BORDER BOARD - TERASSI REUNALAUTA - TERASSFODERBRÄDE	60	3.5	35
068	SCREWS - RUUVIT - SKRUVAR		BOARD FOR SETTLEMENT SLOT - LAUTA PAINUMISRAKONN- - BRÄDE FÖR SÄTTNINGSSPRINGA	9	2.5	25
Kood	S4020-90 Folkbastun	Material	File	S4020-90 Folkbastun.dwg	Leht	14

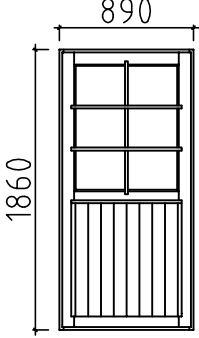
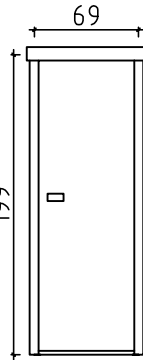
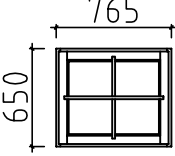
Pos	S4020-90 Folkbastun	Pcs.	Profile (mm)	L (mm)
	<p data-bbox="284 230 1070 268">Door-ovi-dörr 890x1900 (right-oikea käsi-höger hand) 1pc</p>  <p data-bbox="264 645 1051 683">Door-ovi-dörr 690x1900 (right-oikea käsi-höger hand) 1pc</p>  <p data-bbox="272 1072 1201 1111">Window-ikkuna-fönster 765x650 (left-vasen käsi-vänster hand) 1pc</p> 			
Kood	S4020-90 Folkbastun	Materjal	File	S4020-90 Folkbastun.dwg
			Leht	15

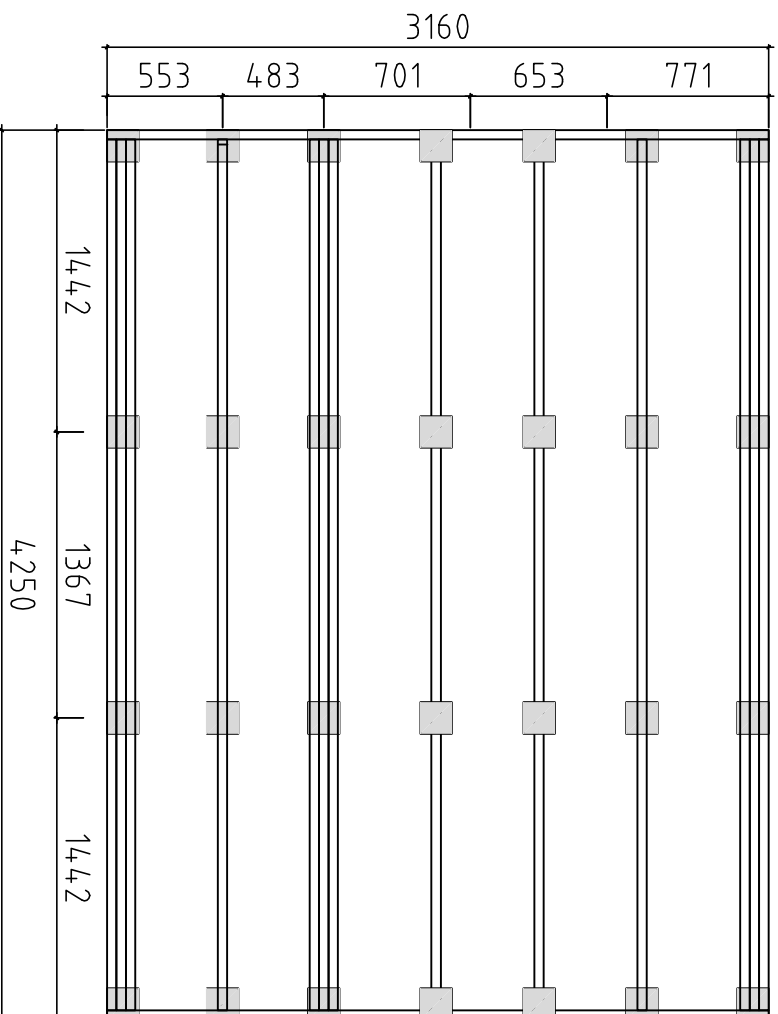

Detta är ett förslag för hur man kan placera plintarna (100-200 mm i diamaten) för golvvägglaget. Golvväggarna är med i byggsatsen, men inte plintarna. Använder man exempelvis 500-600mm långa murblock så kan man halvera antalet punkter. Lägg fuktskyddande papp mellan betong och trä

Tämä on ehdotus siitä, miten (100-200 mm läpimittaiset) jalat voidaan sijoittaa alapohjan varten. Lattiapaikit ovat rakennussarjassa, mutta jalat ei ole. Kun käytetään esimerkiksi 500-600 mm pitkiä harkkoja, voidaan pisteiden määrä puolittaa. Aseta betonin ja puun väliin kosteudelta suojaava paperi

A proposal for placing plinths (100-200 mm in diameter) for floor beams. Floor beams are provided in the kit but plinths are not included. For example, by using 500-600 mm long masonry units, one can reduce the number of points 50%. Place cardboard between the concrete and wood to protect from moisture

Date rev. Description

House S4020-90 Folkbastun Sheet 16

Drawing Plan Scale 1:35

Material Date 14.11.2016

Drawer K.K. File S4020-90 Folkbastun.dwg

