

Date	rev.	Description
------	------	-------------

House	P584.3-4.4	Louise	Sheet	1
-------	------------	--------	-------	---

Drawing	3D	Scale	
---------	----	-------	--

Material	4.4x135	Date	01.02.2016
----------	---------	------	------------

Drawer	RP	File	P584.3-4.4, Louise 3D.dwg
--------	----	------	---------------------------

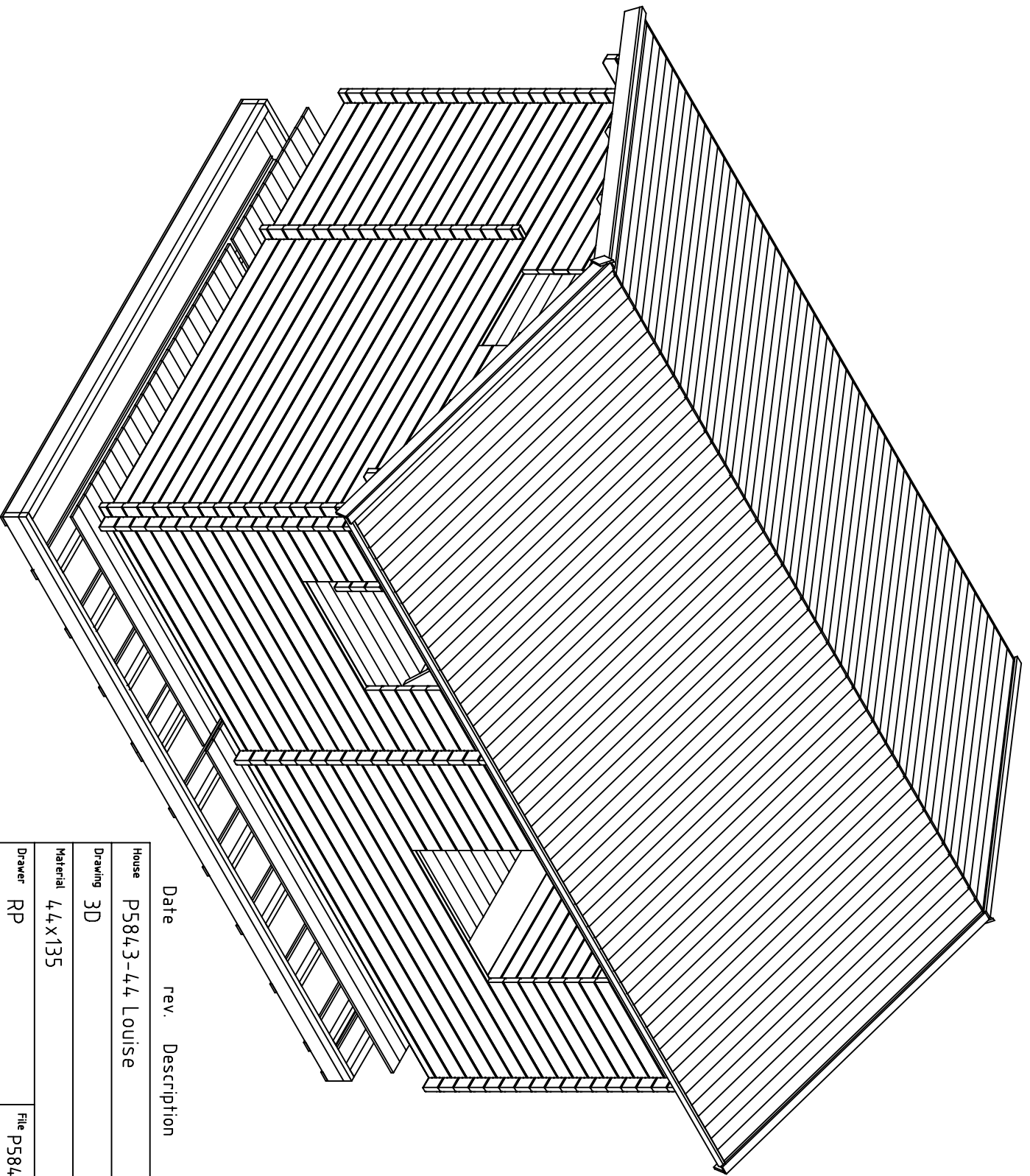

Date	rev.	Description	Sheet
------	------	-------------	-------

		P5843-44 Louise	2
--	--	-----------------	---

House	P5843-44 Louise	Sheet	2
-------	-----------------	-------	---

Drawing	3D	Scale	
---------	----	-------	--

Material	4,4x135	Date	01.02.2016
----------	---------	------	------------

Drawer	RP	File	P5843-44 Louise 3D.dwg
--------	----	------	------------------------

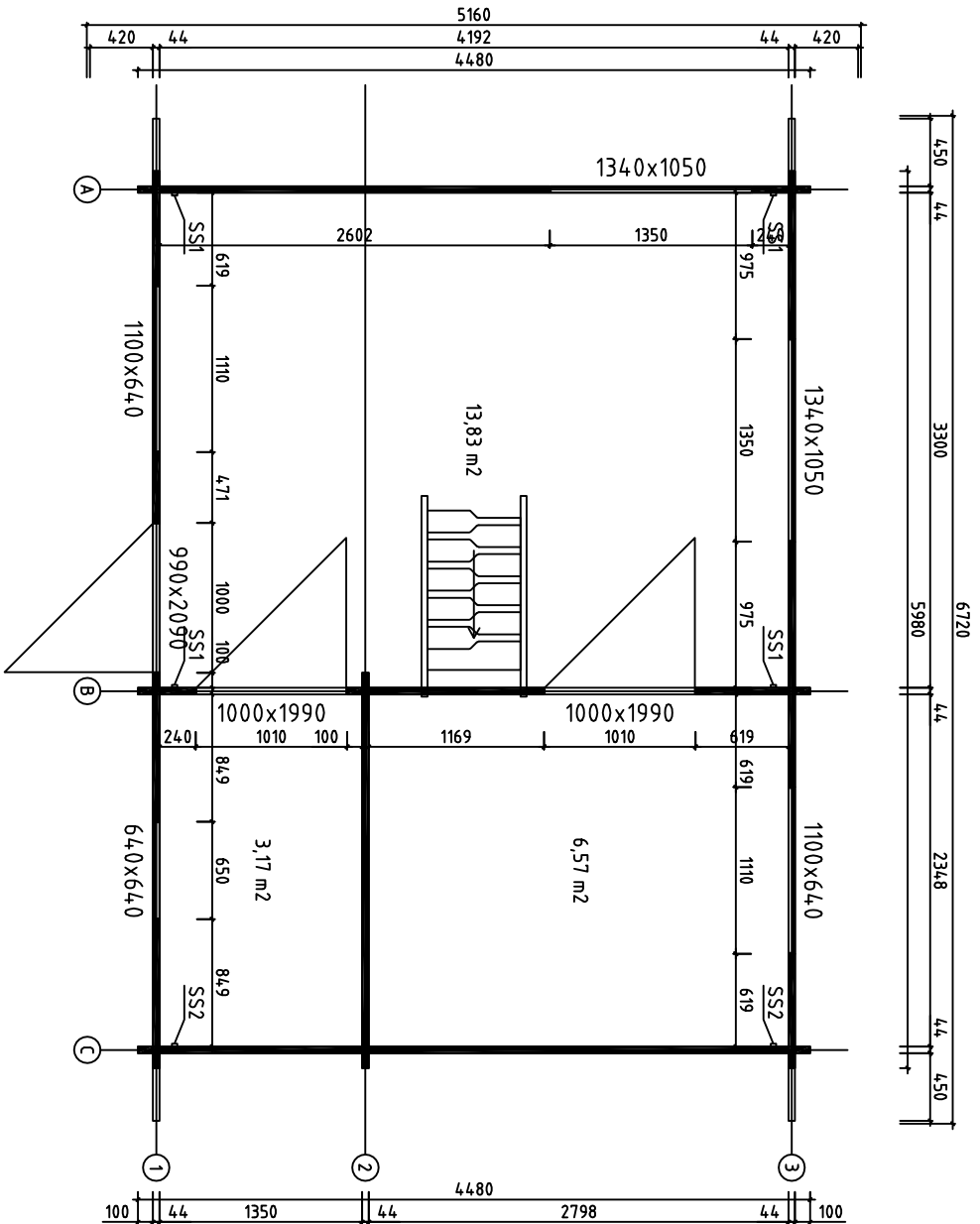

House	P5843-44 Louise	Sheet	3
Drawing	PLAN-SUUNNITELMA-PLANEN	Scale	1:50
Material	4,4x135	Date	01.02.2016
Drawer	RP	File	P5843-44 Louise.dwg

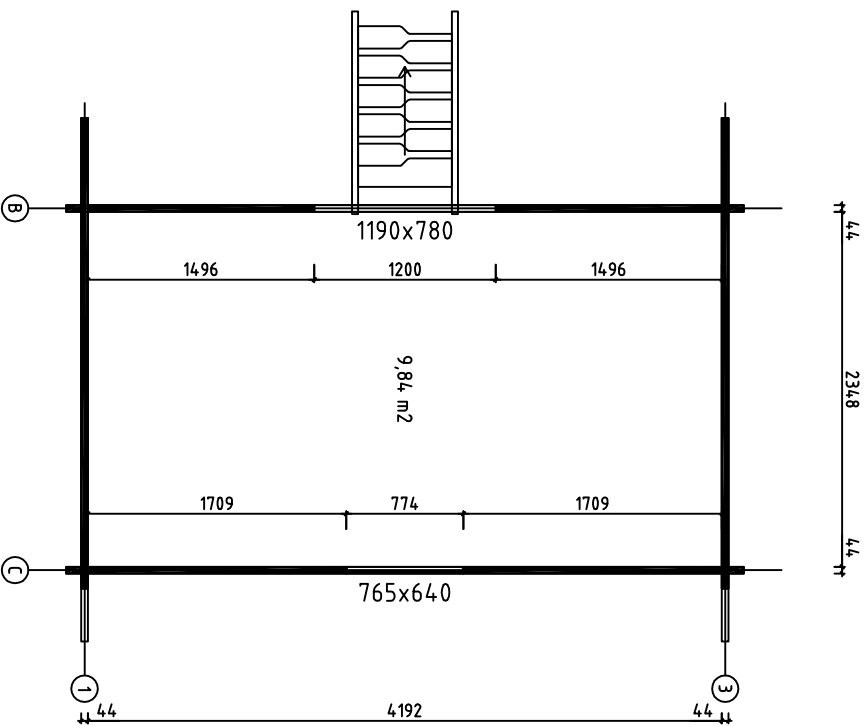
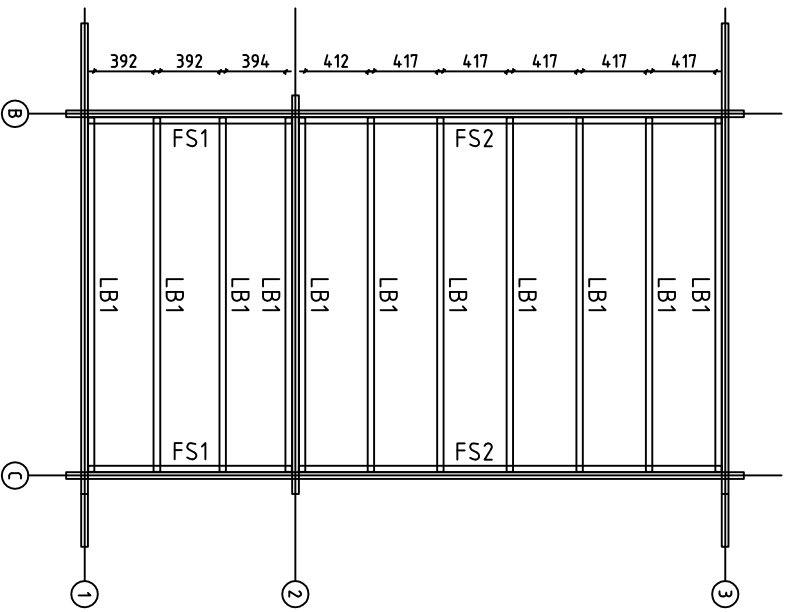

LOFT FLOOR BEAMS - PARVIA LATTIAPALKIT - LOFT GOLVBJÄLKAR

House	P5843-44 Louise		Sheet	4
Drawing	LOFT FLOOR - PARVIA LATTIA - LOFT GOLV		Scale	1:50
Material	4,3x4,3, 4,3x14,0	4,4x135	Date	01.02.2016
Drawer	RP	File	P5843-44 Louise.dwg	

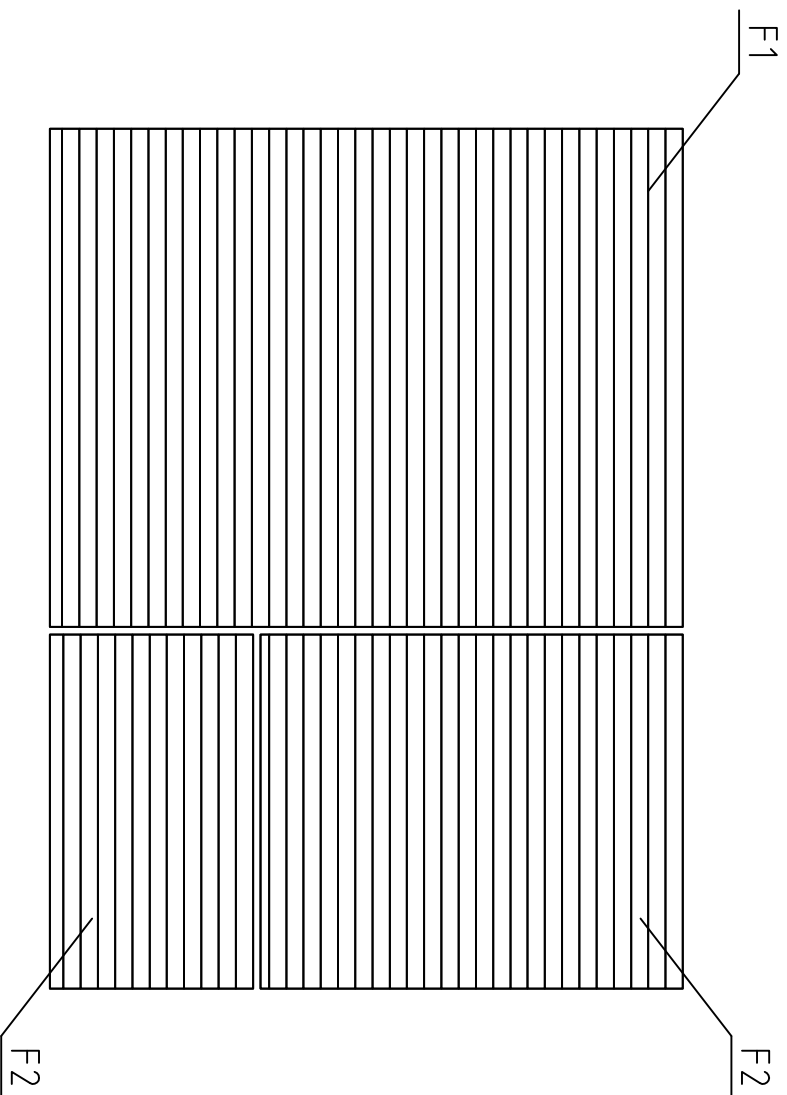

FLOORBOARD-LATTIALAUTA-GOLVBRÄDE

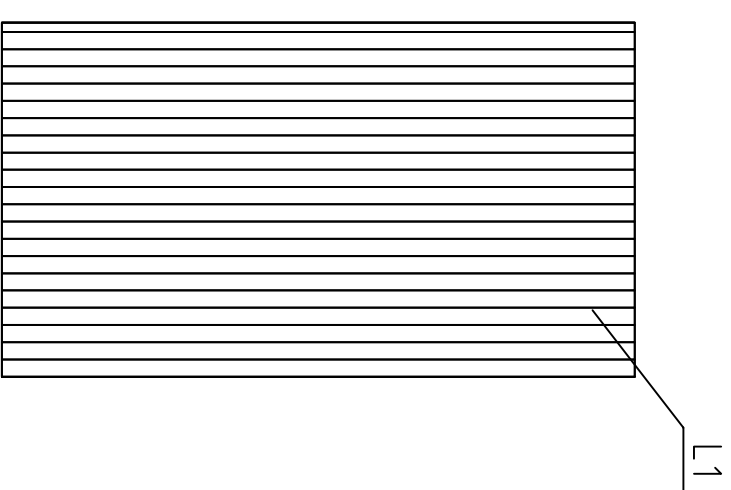

LOFT FLOORBOARD - PARVIA LATTIALATTIA - LOFT GOLVBRÄDE

House	P5843-44 Louise	Sheet	5
Drawing	FLOORBOARD-LATTIALAUTA-GOLVBRÄDE	Scale	1:50
Material	114x19	Date	01.02.2016
Drawer	RP	File	P5843-44 Louise.dwg

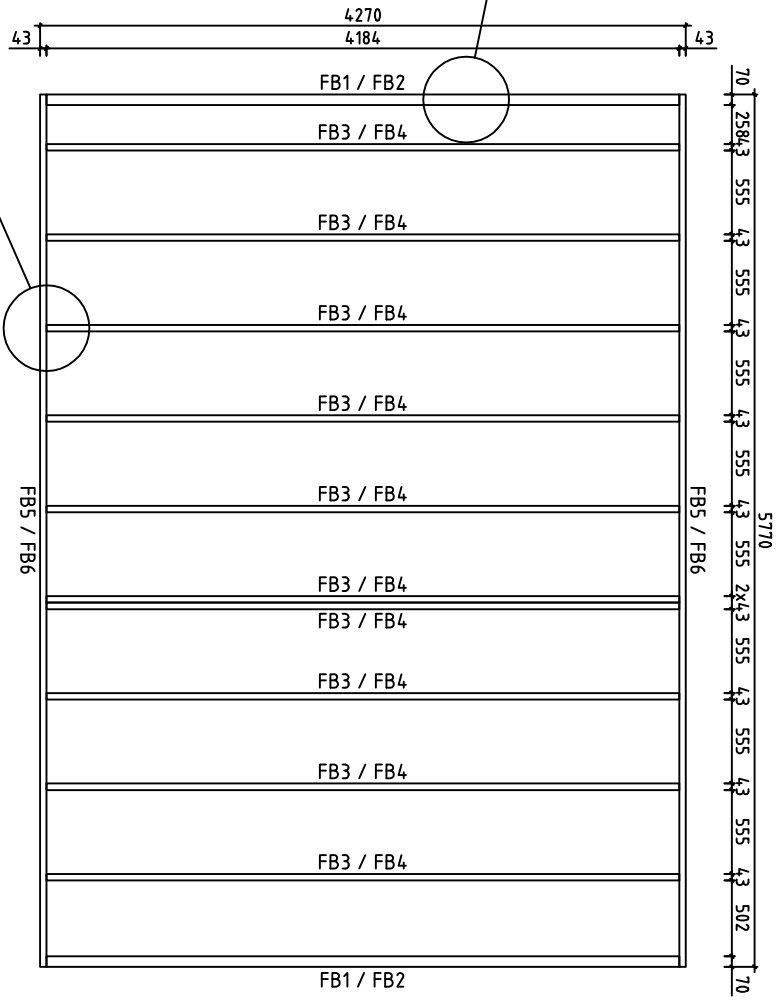
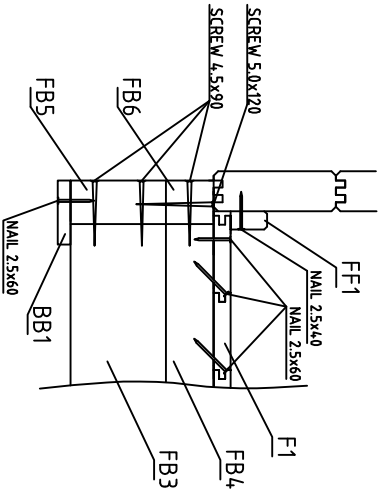
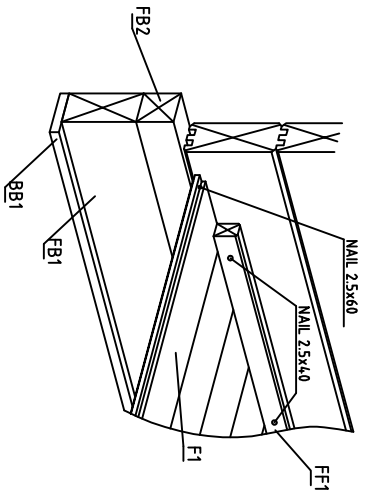



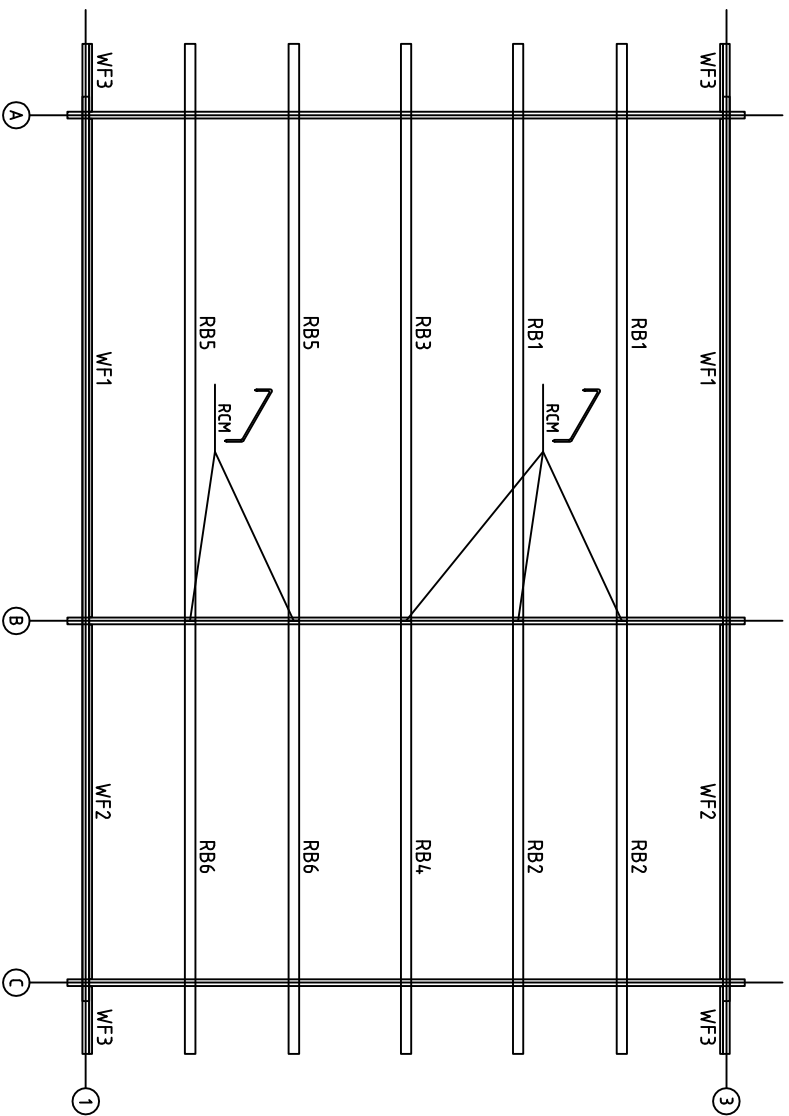



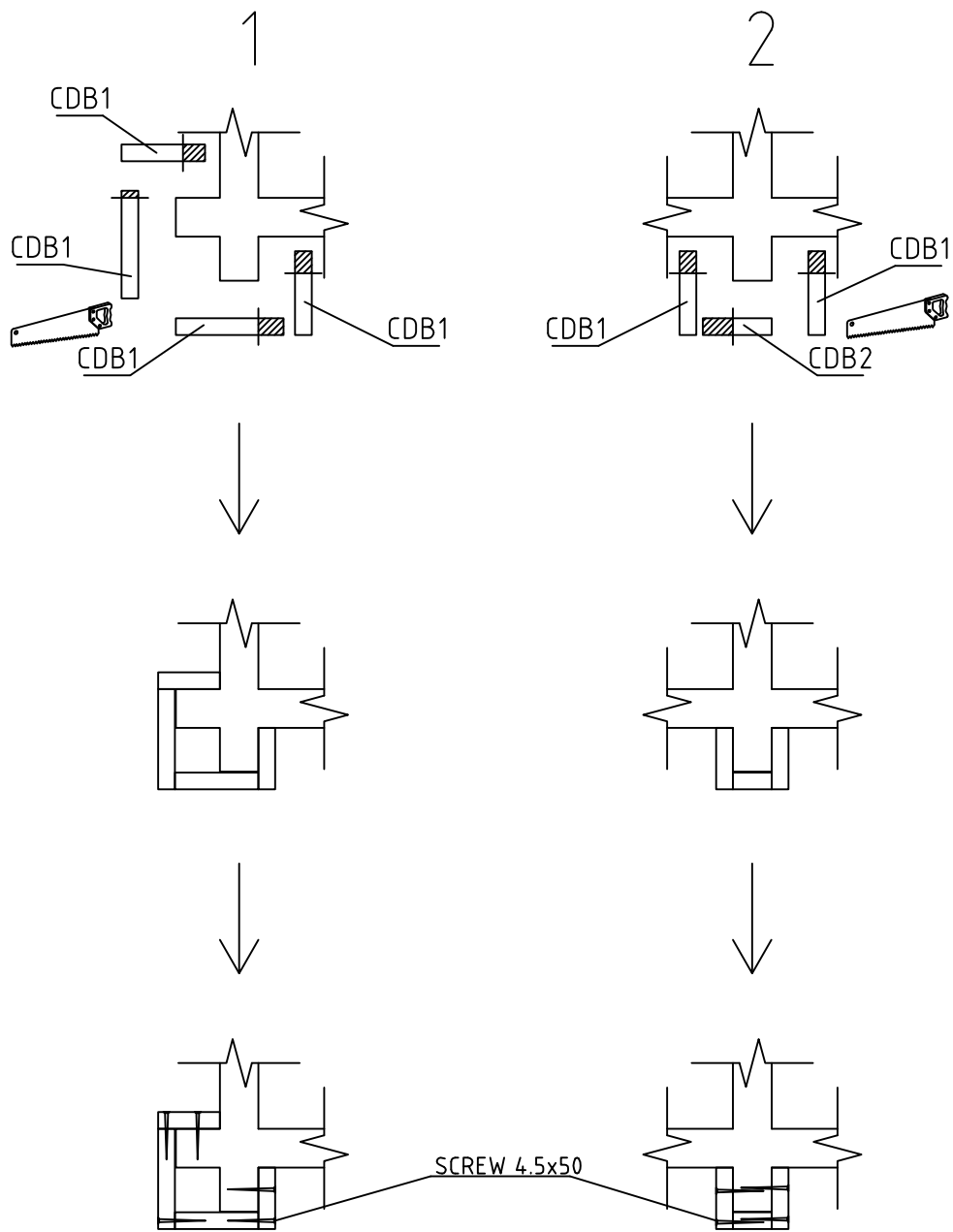
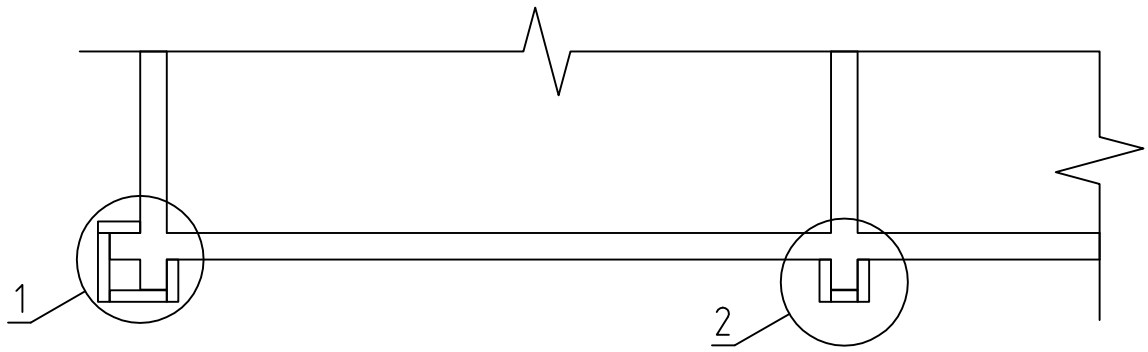



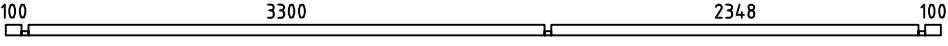
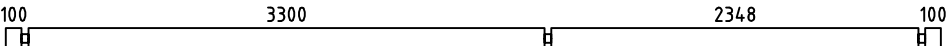

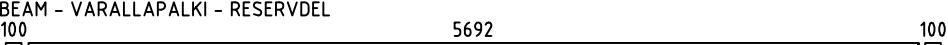

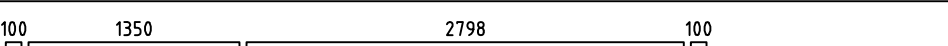
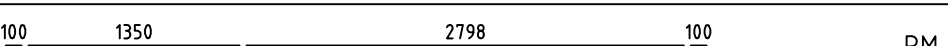
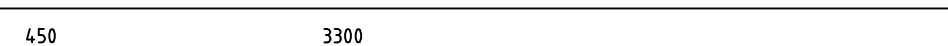
House	P5843-44 Louise	Sheet	6
Drawing	FLOORBEAMS-LATTIAPALKIT-GOLVBJÄLKAR	Scale	1:50
Material	70x140, 70x70, 43x140, 43x70	Date	01.02.2016
Drawer	RP	File	P5843-44 Louise.dwg

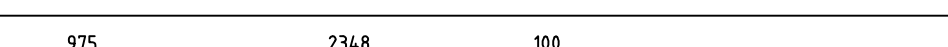
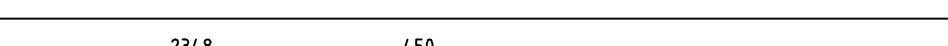
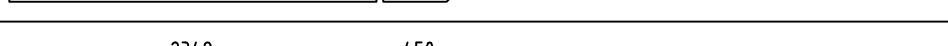
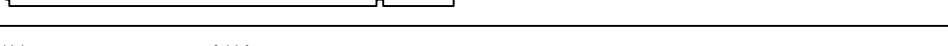
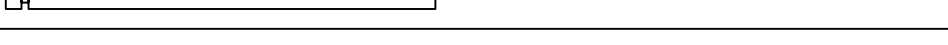
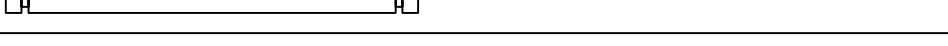
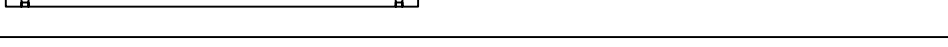
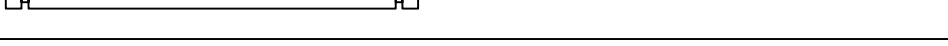
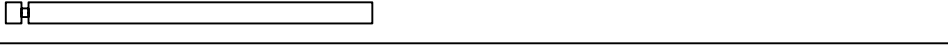











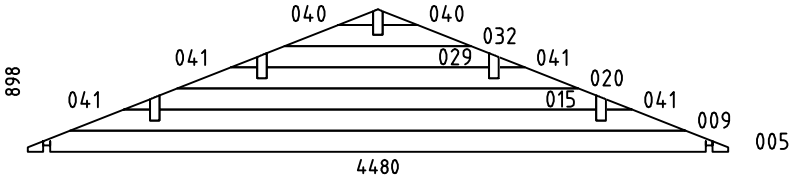
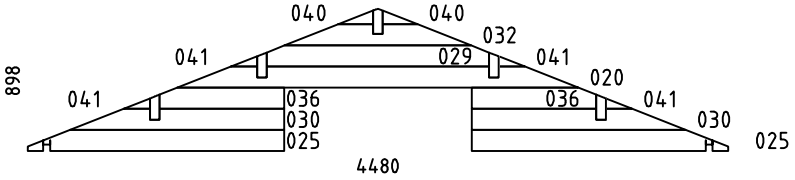
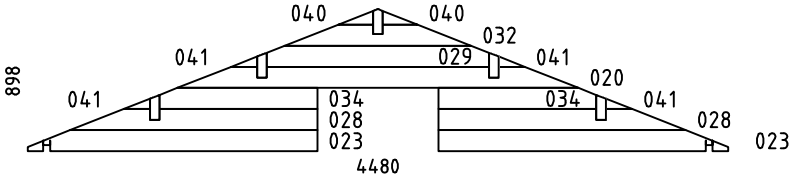

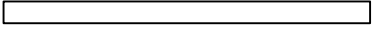
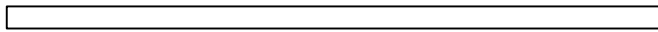
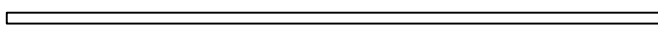
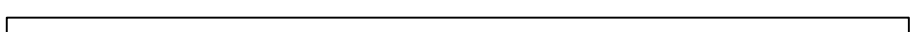
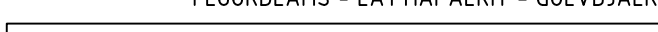
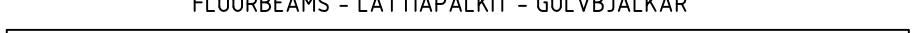
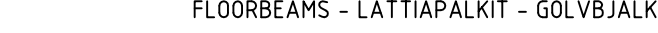



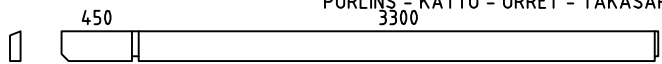
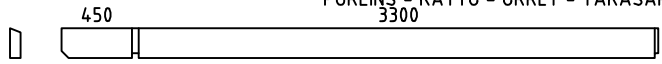
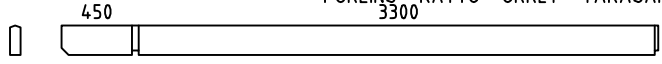









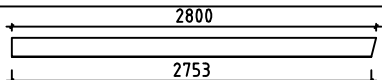







House	P5843-44 Louise	Sheet	13
Drawing	PURLINS-KATTO-ORRET-TAKÅSAR	Scale	1:50
Material	68x190, 19x70	Date	01.02.2016
Drawer	RP	File	P5843-44 Louise.dwg



















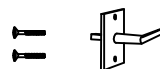
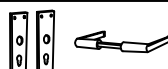

House	P5843-44 Louise	Sheet	14
Drawing	CORNER DECORATION - HÖRN DEKORATION	Scale	1:50
Material		Date	01.02.2016
Drawer	RP	File	P5843-44 Louise.dwg

Pos	P5843-44 Louise	Pcs. St.	Profil(e) (mm)	L (mm)
001		1	44x68	5980
002		12	44x135	5980
003		1	44x135	5980
004	SPARE BEAM - VARALLAPALKI - RESERVDEL 	1	44x135	5980
006		13	44x135	4480
007		18	44x135	4480
008		PM 1	44x135	4480
010		2	44x135	3816
011		PM 2	44x135	3816
012		3	44x135	3511
013		2	44x135	2864
014		PM 2	44x135	2864
016		8	44x135	2746
017		26	44x135	2636
018		2	44x68	2636
019		1	44x68	2636
021		10	44x135	2344
022		1	44x68	2344
024		4	44x135	1853
026		6	44x135	1640
027		5	44x135	1638
031		15	44x135	1313
033		8	44x135	1119
035		10	44x135	993
037		25	44x135	763
House P5843-44 Louise		Material	File P5843-44 Louise.dwg	Sheet 15

Pos	P5843-44 Louise	Pcs. St.	Profil(e) (mm)	L (mm)
038		5	44x135	471
039		23	44x135	384
WA-1		1	44x898	4480
WB-1		1	44x898	4480
WC-1		1	44x898	4480
HB	HIT BLOCK-ASENNUSPALKI-SLAG BRÄDA 	2	44x135	300
LB1	LOFT FLOOR BEAMS-PARVIAPALKIT-LOFTBJÄLKAR 	11	43x140	2345
FB1	FLOORBEAMS - LATTIAPALKIT - GOLVBJÄLKAR 	2	70x140	4184
FB2	FLOORBEAMS - LATTIAPALKIT - GOLVBJÄLKAR 	2	70x70	4184
FB5	FLOORBEAMS - LATTIAPALKIT - GOLVBJÄLKAR 	2	43x140	5770
FB3	FLOORBEAMS - LATTIAPALKIT - GOLVBJÄLKAR 	10	43x140	4184
FB6	FLOORBEAMS - LATTIAPALKIT - GOLVBJÄLKAR 	2	43x70	5770
FB4	FLOORBEAMS - LATTIAPALKIT - GOLVBJÄLKAR 	10	43x70	4184
BB1	COUNTERFLOOR HOLDING BOARDS-ROSSIPOHJAA KANNATTELEVAT LAUDAT-BRÄDER SOM HALLER TROSSBOTTEN 	12	90x19	4270
FS2	SLEEPING FLOOR SUPPORTING SLAT-PARVIALATTIA TUKILISTA -LOFTGOLVLIST 	2	43x43	2795
FS1	SLEEPING FLOOR SUPPORTING SLAT-PARVIALATTIA TUKILISTA -LOFTGOLVLIST 	2	43x43	1345
RB5	PURLINS - KATTO - ORRET - TAKASAR 	2	68x190	3816
RB1	PURLINS - KATTO - ORRET - TAKASAR 	2	68x190	3816
RB3	PURLINS - KATTO - ORRET - TAKASAR 	1	68x190	3816
House P5843-44 Louise		Material	File P5843-44 Louise.dwg	Sheet 16

Pos	P5843-44 Louise		Pcs. St.	Profil(e) (mm)	L (mm)
RB6		2348 PURLINS - KATTO - ORRET - TAKASAR 450	2	68x190	2864
RB2		2348 PURLINS - KATTO - ORRET - TAKASAR 450	2	68x190	2864
RB4		2348 PURLINS - KATTO - ORRET - TAKASAR 450	1	68x190	2864
F1	FLOORBOARD - LATTIALAUTA - GOLVBRÄDE	 114 or-tai-eller 88	37+1 48+1	114x19 88x19	3295
F2	FLOORBOARD - LATTIALAUTA - GOLVBRÄDE	 114 or-tai-eller 88	37+1 48+1	114x19 88x19	2340
L1	LOFT BOARD - PARVIALATTIA - LOFTGOLV	 114 or-tai-eller 88	21+1 28+1	114x19 88x19	4185
R1	ROOFBOARD - KATTOLAUTA - TAKBRÄDE	 114 or-tai-eller 88	118+2 154+2	114x19 88x19	2750
FF1	SKIRTING SLAT - LATTIALISTA - GOLVLIST			19x35	47 m
GB1	GABLE BOARD - KAAPILAUTA - GAVELBRÄDA	 2800 2753	4	19x120	2800
GS1	BOARD MATCHING WITH GABLE BOARD-KAAPILAUTA VASTAVA LAUTA-BRÄDA OVANPÅ GAVELBRÄDA		4	19x70	2800
EB1	EAVE BOARD - RÄYSTÄSLAUTA - TAKFOTBRÄDE		4	19x90	3340
ES1	EAVE SLAT - RÄYSTÄSLISTA - TAKFOTLIST		4	30x40	3340
DB1	DECORATIVE - KORISTE - PRYDNADS		2	19x90	200
CDB1	CORNER DECORATION BOARD- HÖRN DEKORATION BRÄDE		22	120x19	2790
CDB2	CORNER DECORATION BOARD- HÖRN DEKORATION BRÄDE		3	90x19	2790
WF1	SIDEWALL SKIRTING SLAT-KATTOLISTA-PÄÄDYT -TAKLIST-GAVLAR	 63 70	2	19x70	3296
WF2	SIDEWALL SKIRTING SLAT-KATTOLISTA-PÄÄDYT -TAKLIST-GAVLAR	 63 70	2	19x70	2344
WF3	SIDEWALL SKIRTING SLAT-KATTOLISTA-PÄÄDYT -TAKLIST-GAVLAR	 63 70	4	19x70	448
CB1	COVERING BOARD-PEITELAUTA-HYLLBRÄDA		1	19x120	2900
SB1	SUPPORT BOARD-TUKILAUTA-KONSOL		2	19x79	155
SS1	STORM SLAT-MYRSKY LISTA-OVÄDER SPJÄLA		4	19x35	2700
SS2	STORM SLAT-MYRSKY LISTA-OVÄDER SPJÄLA		2	19x35	2020
RCM	ROOFBEAMS CONNECTING METAL-METALL FÖR SAMMANFOGNING AV TAKASAR-KATTO-ORRE YHTEENLITYSMETALLT		5	∅6	200
WCM	WALLBEAMS CONNECTING METAL-METALLPLATTA FÖR SAMMANFOGNING AV VÄGGEN BALKAR-SEINÄPALKKEJA METALLISET YHTEENLIITYMISLAATAT		4	25	25
	SCREWS-RUUVIT-SKRUVAR FOR-VARTEN-FÖR SS1, SS2		18	∅6	50
	WASHER-ALUSLAATTA-BRICKA FOR-VARTEN-FÖR SS1, SS2		18	∅6	
House P5843-44 Louise		Material	File P5843-44 Louise.dwg	Sheet 17	

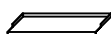
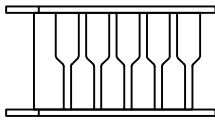
Pos	P5843-44 Louise		Pcs. St.	Profil(e) (mm)	L (mm)	
	NAILS-NAULAT-SPIKAR FOR-VARTEN-FÖR	FF1		110	∅2.0	40
	NAILS-NAULAT-SPIKAR FOR-VARTEN-FÖR	F1, F2, L1, R1, BB1		1600	∅2.5	60
	SCREWS-RUUVIT-SKRUVAR FOR-VARTEN-FÖR	WCM		20	∅3.5	35
	SCREWS-RUUVIT-SKRUVAR FOR-VARTEN-FÖR	GB1, GS1, EB1, ES1, DB1, CB CDB1, CDB2, WF1, WF2, WF3		300	∅4.5	50
	SCREWS-RUUVIT-SKRUVAR FOR-VARTEN-FÖR	FS1, FS2, LB1, SB		50	∅4.5	70
	SCREWS-RUUVIT-SKRUVAR FOR-VARTEN-FÖR	001, 018, 019, 022 FB1, FB2, FB3, FB4, FB5, FB6		70	∅4.5	90
	SCREWS-RUUVIT-SKRUVAR FOR-VARTEN-FÖR	FB2, FB4, FB6		60	∅5.0	120
	SCREWS-RUUVIT-SKRUVAR FOR-VARTEN-FÖR	RB1, RB2, RB3, RB4, RB5, RB6		20	∅6.0	160
	WINDOW HANDLE-IKKUNA KAHVA-FÖNSTER HANDTAG FOR-VARTEN-FÖR	W1, W2, W3, W4		8		
	DOOR HANDLE-OVEN KAHVA-DÖRR HANDTAG FOR-VARTEN-FÖR	D1, D2		3		
	DOOR LOCK+KEYS-OVENLUKKO+AVAIN-DÖRRLAS+NYCKLAR FOR-VARTEN-FÖR	D1, D2		3		
	DOOR CROSSES-OVENLISTAT-SPRÖJS FOR-VARTEN-FÖR	D1		1		
	WINDOW CROSSES-IKKUNALISTAT-SPRÖJS FOR-VARTEN-FÖR	W1		4		
	WINDOW CROSSES-IKKUNALISTAT-SPRÖJS FOR-VARTEN-FÖR	W2		2		
	WINDOW CROSSES-IKKUNALISTAT-SPRÖJS FOR-VARTEN-FÖR	W3		1		
	WINDOW CROSSES-IKKUNALISTAT-SPRÖJS FOR-VARTEN-FÖR	W4		1		
	WINDOW WATER SILL-IKKUNALAUTA-FÖNSTERBLECK FOR-VARTEN-FÖR	W1		2		
	WINDOW WATER SILL-IKKUNALAUTA-FÖNSTERBLECK FOR-VARTEN-FÖR	W2		2		
	WINDOW WATER SILL-IKKUNALAUTA-FÖNSTERBLECK FOR-VARTEN-FÖR	W3		1		
	WINDOW WATER SILL-IKKUNALAUTA-FÖNSTERBLECK FOR-VARTEN-FÖR	W4		1		
LD1	LADDER-TIKAPUUT-STEGE			1	700	2760
House P5843-44 Louise		Material	File P5843-44 Louise.dwg	Sheet 18		

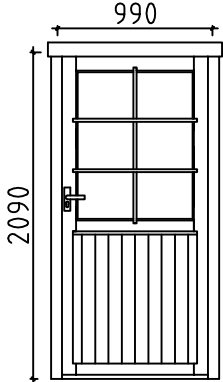
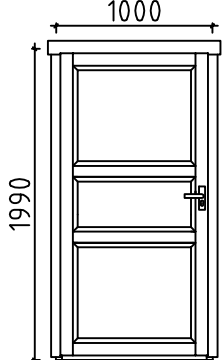
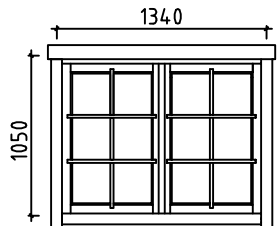
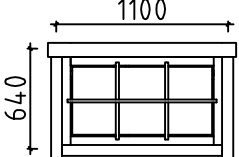
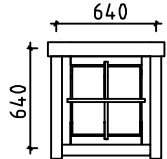
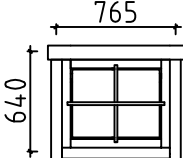
Pos	P5843-44 Louise	Pcs. St.	Profil(e) (mm)	L (mm)	
D1	DOOR-OVI-DÖRR (right-oikea-höger) ORT_ST 	P	1	990	2090
D2	DOOR-OVI-DÖRR (left-jäljellä-vänster) AST 	V	2	1000	1990
W1	WINDOW-IKKUNAN-FÖNSTER ORT_ST 		2	1340	1050
W2	WINDOW-IKKUNAN-FÖNSTER (right-oikea-höger) ORT_ST_SU 		2	1100	640
W3	WINDOW-IKKUNAN-FÖNSTER (right-oikea-höger) ORT_ST 	P	1	640	640
W4	WINDOW-IKKUNAN-FÖNSTER (right-oikea-höger) ORT_ST_SU 		1	765	640
House P5843-44 Louise		Material	File P5843-44 Louise.dwg	Sheet 19	

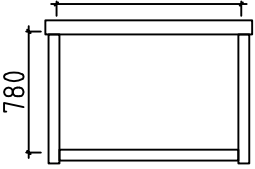
Pos	P5843-44 Louise	Pcs. St.	Profil(e) (mm)	L (mm)
FL1	<p data-bbox="263 145 662 212">FRAME AROUND LOFT ENTRANCE</p> <p data-bbox="383 174 438 206">1190</p>  <p data-bbox="263 268 295 324">780</p>	1	1190	780
House P5843-44 Louise	Material	File P5843-44 Louise.dwg		Sheet 20

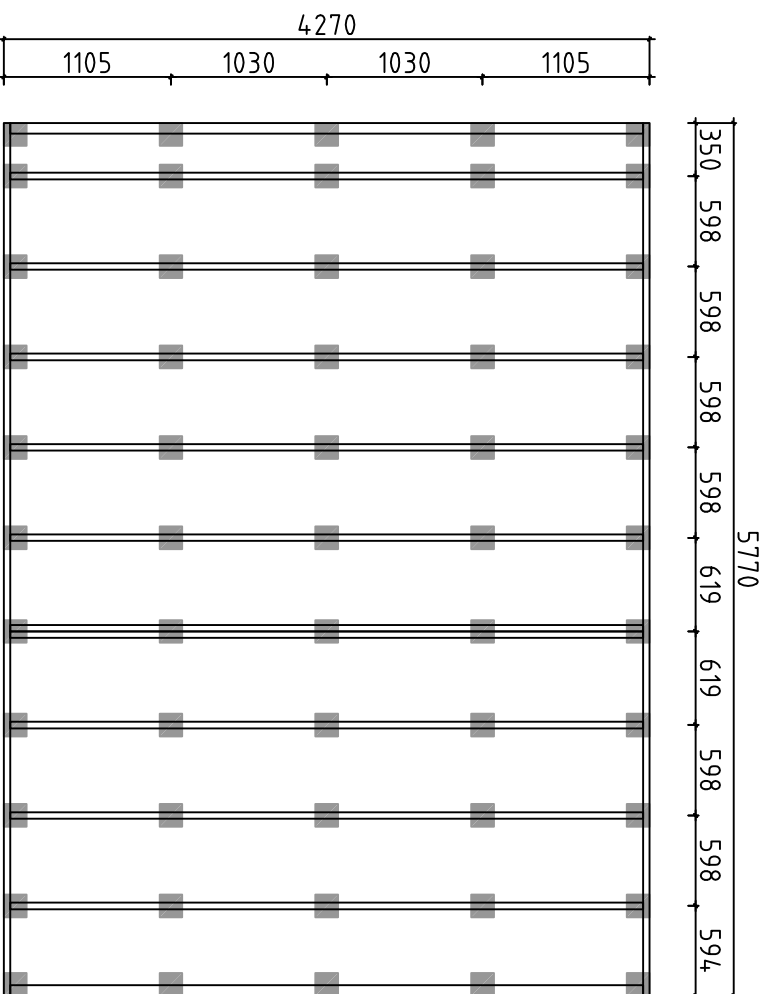

Detta är ett förslag för hur man kan placera plintarna (100-200 mm i diameter) för golvbjälklaget. Golvbjälkarna är med i byggsatsen, men inte plintarna. Använder man exempelvis 500-600mm långa murblock så kan man halvera antalet punkter. Lägg fuktskyddande papp mellan betong och trä

Tämä on ehdotus siltä, miten (100-200 mm läpimitäiset) jalat voidaan sijoittaa alapohjaa varten. Lattiapalkit ovat rakennussarjassa, mutta jalkoja ei ole. Kun käytetään esimerkiksi 500-600 mm pitkiä harkkoja, voidaan pisteiden määrä puoltaa. Aseta betonin ja puun väliin kosteudelta suojaava pahvi

A proposal for placing plinths (100-200 mm in diameter) for floor beams. Floor beams are provided in the kit but plinths are not included. For example, by using 500-600 mm long masonry units, one can reduce the number of points 50%. Place cardboard between the concrete and wood to protect from moisture

House	P5843-44 Louise	Sheet	21
Drawing	PLINTPLAN - FOUNDATION PLAN	Scale	1:50
Material		Date	01.02.2016
Drawer	RP	File	P5843-44 Louise Foundation.dwg

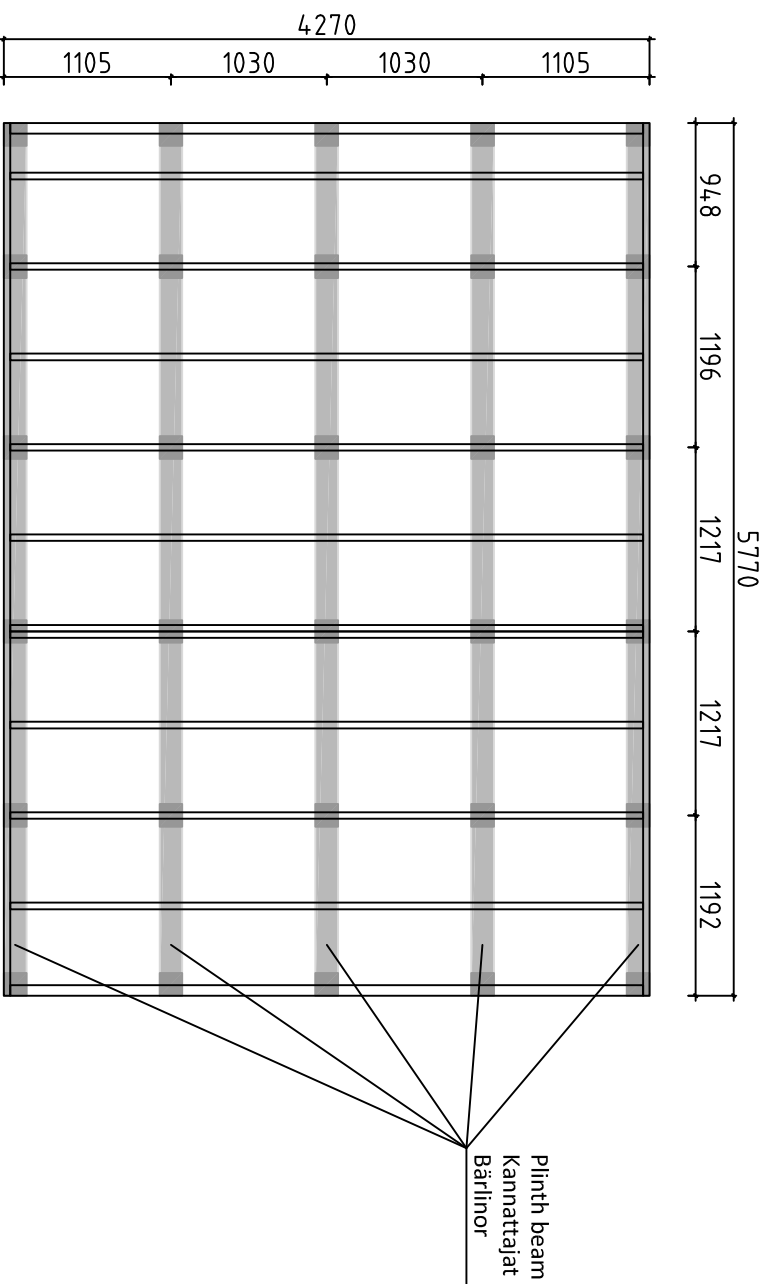

Förslag på alternativ plintplan med bärlnor och plintar. Bärlnor 45x95 eller 45x120 och plintar ca 100-200 mm i diameter. (Bärlnor och plintar ingår ej i leveransen). Används exempelvis murblock, (ingår ej i leveransen) istället för plintar, kan man lägga bärlnorna platt mot dessa och på det sättet minska höjden på konstruktionen. I denna konstruktion kan man dessutom lägga en "boardskiva" mellan bärlnorna och golvbjälkarna och på det sättet bära upp bjälklagsisoleringen. Lagg fuktskyddande papp mellan betong och trä

Endotus valtoehtoisestä jalustasta kannattajilla ja jalolla. Kannattajat 45x95 tai 45x120 ja jalat läpimitataan n. 100-200 mm (kannattajat ja jalat ei ole toimituksessa). Käytettäessä esimerkiksi harkkoja (ei kuulu toimitukseen) jalkojen sijasta, voi kannattajat asettaa lappeelleen niitä vasten ja sillä tavoin vähentää rakenteen korkeutta. Tässä rakenteessa voi lisäksi asettaa levyn kannattajien ja lattiapalkkien väliin ja sillä tavoin kannattaa alapohjan eristystä. Aseta betonin ja puun väliin kosteudelta suojaava pahvi

A proposal for alternative plinth beam layout plan. Plinth beams 45x95 or 45x120 and plinths ca 100-200 mm in diameter (plinth beams and plinths are not included in the kit). For example, by using masonry units (not included in the kit) instead of plinths, one can lay plinth beams flat against the masonry units and in that way reduce the height of the structure. In this construction one can also add "plywood board" between plinth beams. Place cardboard between the concrete and wood to protect from moisture

House	P5843-44 Louise	Sheet	22
Drawing	PLINTPLAN - FOUNDATION PLAN	Scale	1:50
Material		Date	01.02.2016
Drawer	RP	File	P5843-44 Louise Foundation.dwg

#001	3	5980	1
#002	1,3	5980	12
#003	1	5980	1
#004		5980	1
#005	A	4480	1
#006	A,C	4480	13
#007	B,C	4480	18
#008	B	4480	1
#009	A	3937	1
#010	1,3	3816	2
#011	1,3	3816	2
#012	3	3511	3
#013	1,3	2864	2
#014	1,3	2864	2
#015	A	2795	1
#016	A	2746	8
#017	1,2	2636	26
#018	1,2	2636	2
#019	2	2636	1
#020	A,B,C	2565	3
#021	1	2344	10
#022	1	2344	1
#023	C	1853	2
#024	C	1853	4
#025	B	1640	2
#026	B	1640	6
#027	3	1638	5
#028	C	1582	2
#029	A,B,C	1424	3
#030	B	1369	2
#031	B	1313	15
#032	A,B,C	1194	3
#033	3	1119	8
#034	C	1011	2
#035	1	993	10
#036	B	798	2
#037	1,3,B	763	25
#038	1	471	5
#039	A,B	384	23
#040	A,B,C	224	6
#041	A,B,C	168	12