

Date rev. Description

House	P5843-44 Olivia	Sheet	1
-------	-----------------	-------	---

Drawing	3D	Scale	
---------	----	-------	--

Material	4,4x135	Date	05.01.2017
----------	---------	------	------------

Drawer	RP	File	P5843-44, Olivia 3D.dwg
--------	----	------	-------------------------

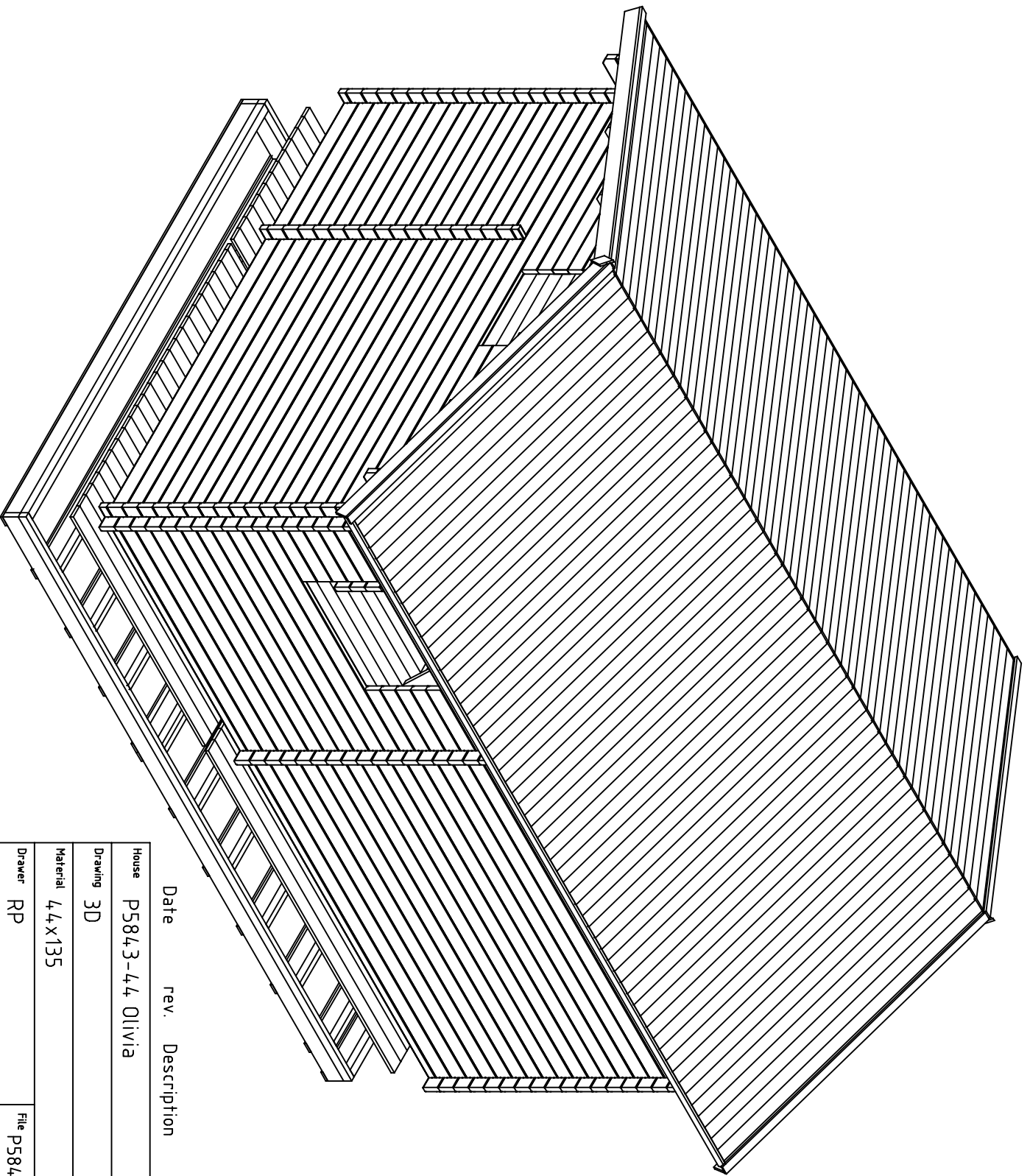

Date rev. Description

House P5843-44 Olivia Sheet 2

Drawing 3D Scale

Material 4,4x135 Date 05.01.2017

Drawer RP File P5843-44 Olivia 3D.dwg

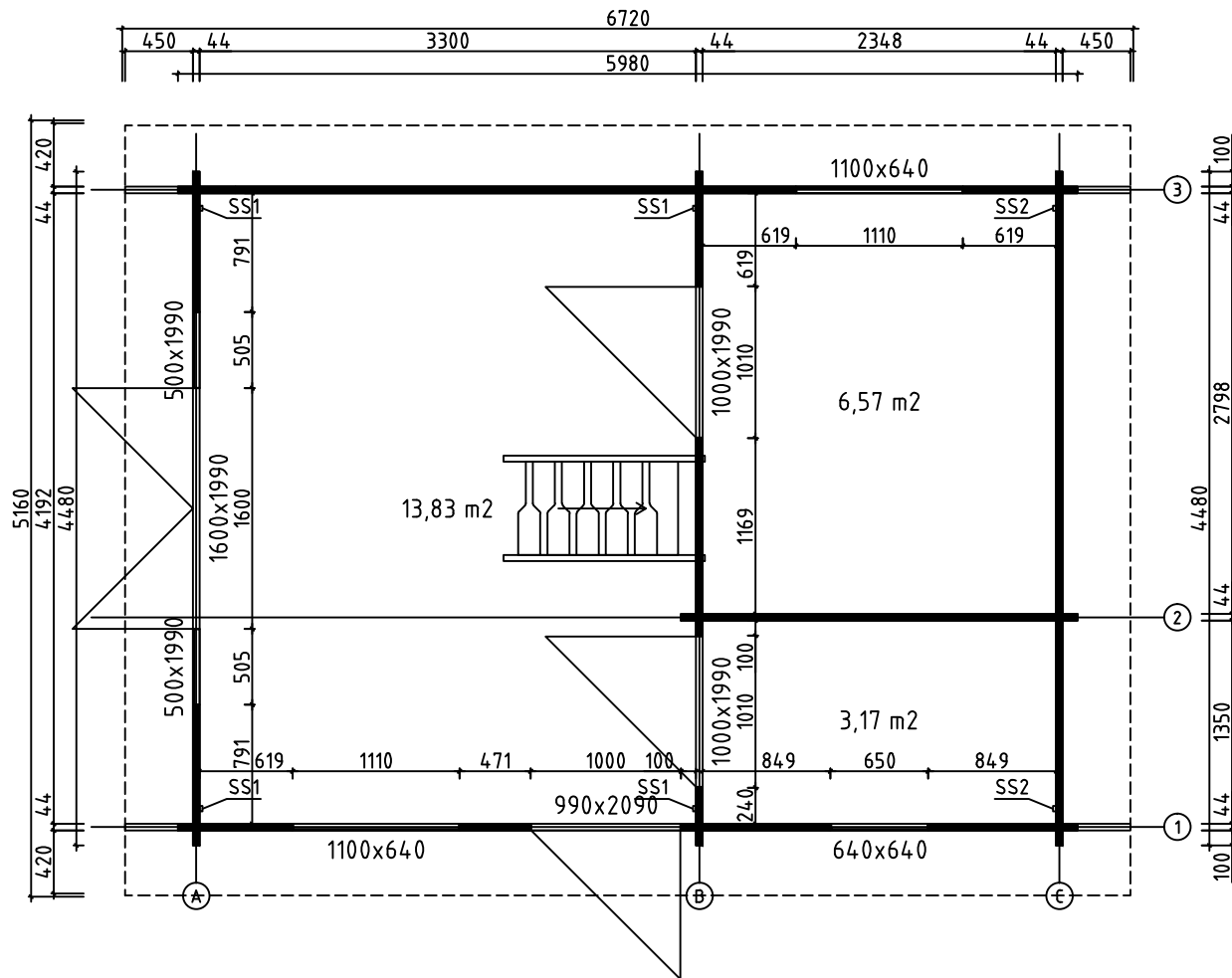

House	P5843-44 Olivia	Sheet	3
Drawing	PLAN-SUUNNITELMA-PLANEN	Scale	1:50
Material	44x135	Date	05.01.2017
Drawer	RP	File	P5843-44 Olivia.dwg

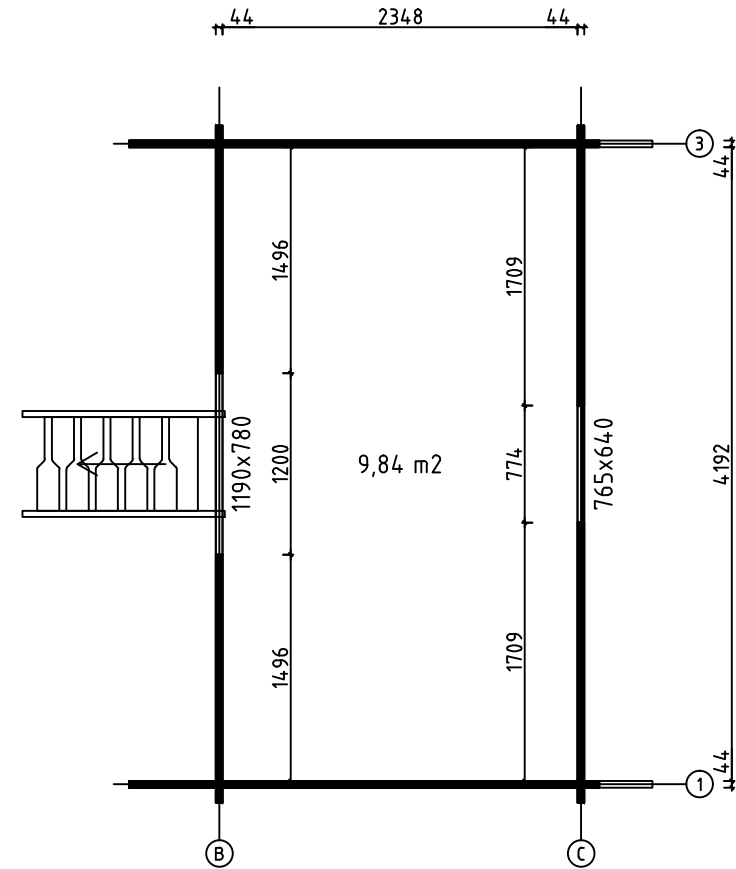
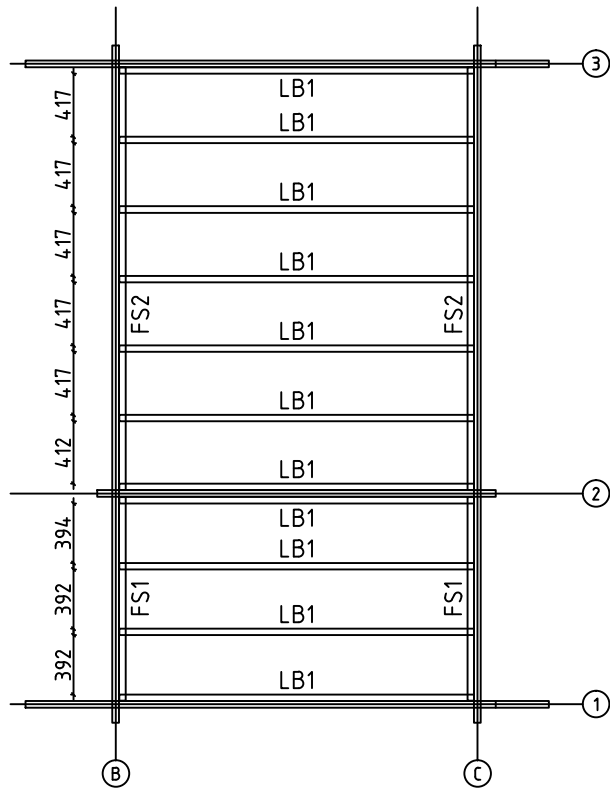

LOFT FLOOR BEAMS - PARVIA LATTIAPALKIT - LOFT GOLVBJÄLKAR

House	P5843-44 Olivia	Sheet	4
Drawing	LOFT FLOOR - PARVIA LATTIA - LOFT GOLV	Scale	1:50
Material	43x43, 43x140 44x135	Date	05.01.2017
Drawer	RP	File	P5843-44 Olivia.dwg

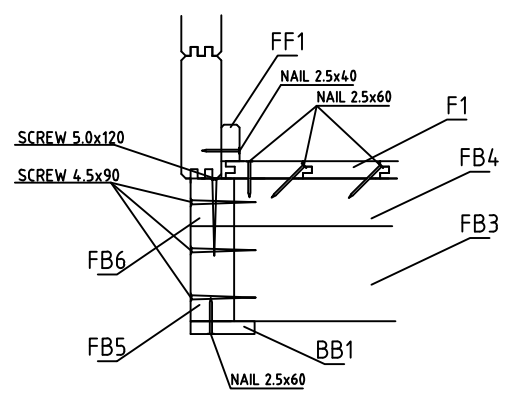
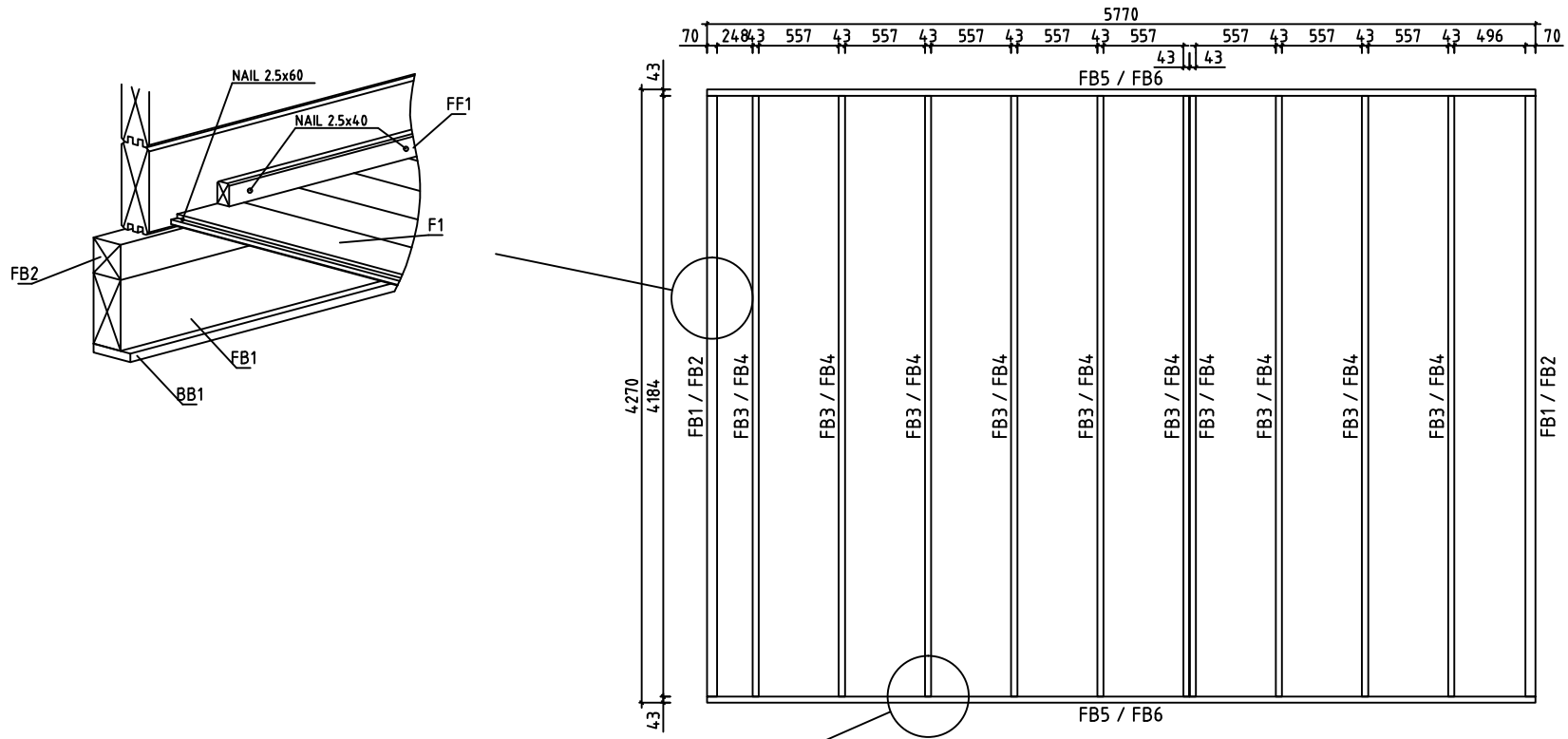

House	P5843-44 Olivia	Sheet	5
Drawing	FLOORBEAMS-LATTIAPALKIT-GOLVBJÄLKAR	Scale	1:50
Material	70x140, 70x70, 43x140, 43x70	Date	05.01.2017
Drawer	RP	File	P5843-44 Olivia.dwg

F1

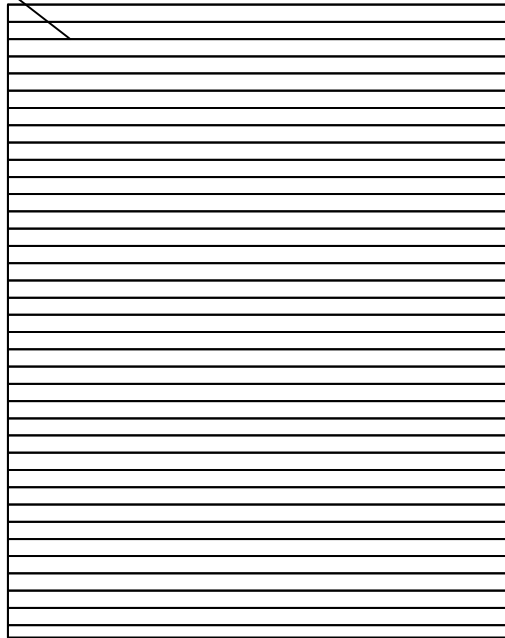

F2

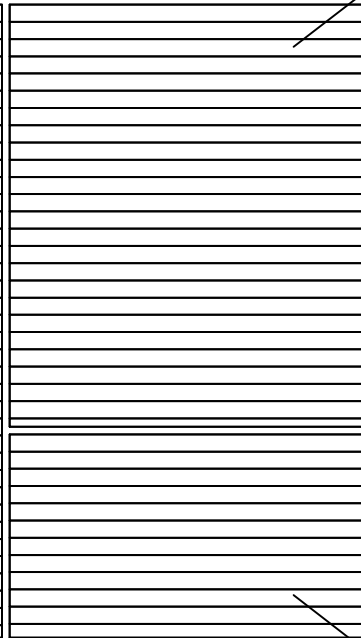

F2

FLOORBOARD-LATTIALAUTA-GOLVBRÄDE

L1

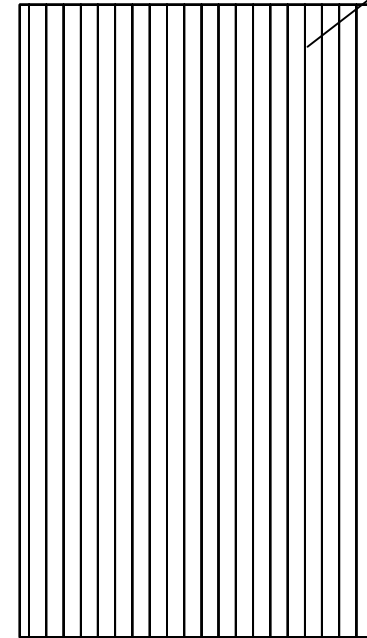

LOFT FLOORBOARD - PARVIA LATTIALATTIA - LOFT GOLVBRÄDE

House	P5843-44 Olivia	Sheet	6
Drawing	FLOORBOARD-LATTIALAUTA-GOLVBRÄDE	Scale	1:50
Material	114x28, 114x19	Date	05.01.2017
Drawer	RP	File	P5843-44 Olivia.dwg

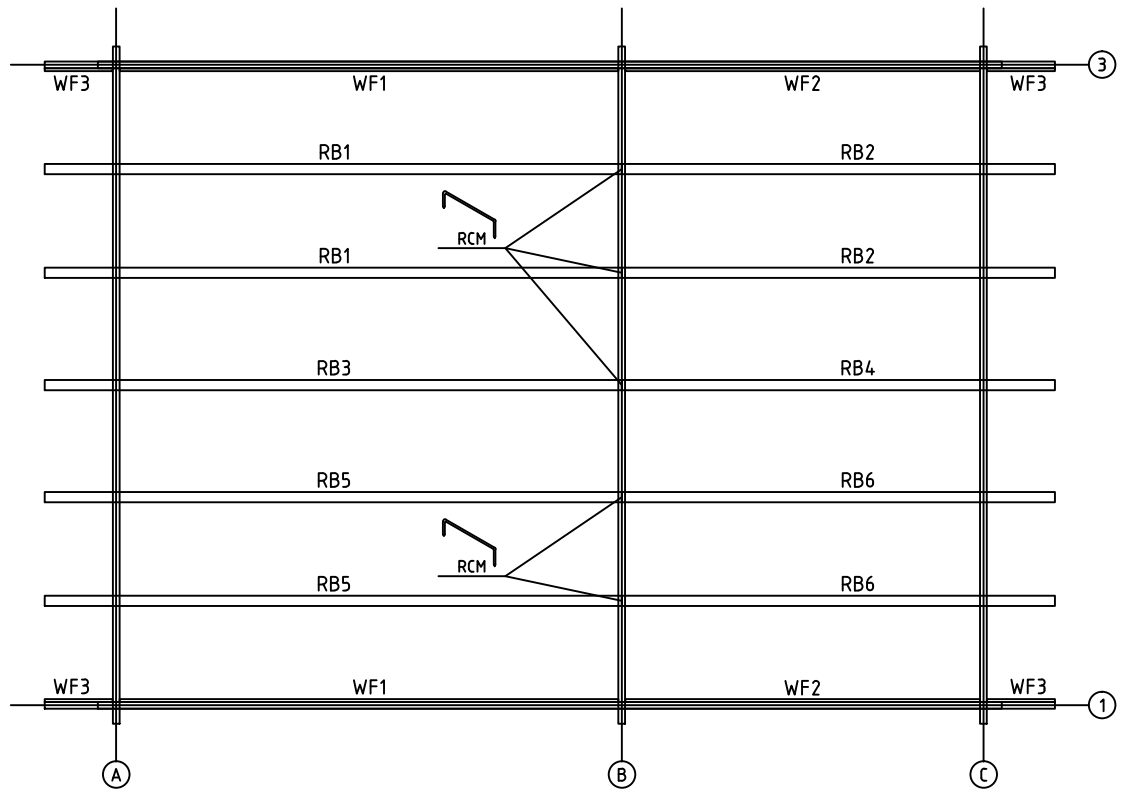

House	P5843-44 Olivia	Sheet	7
Drawing	PURLINS-KATTO-ORRET-TAKÅSAR	Scale	1:50
Material	68x190, 19x70	Date	05.01.2017
Drawer	RP	File	P5843-44 Olivia.dwg

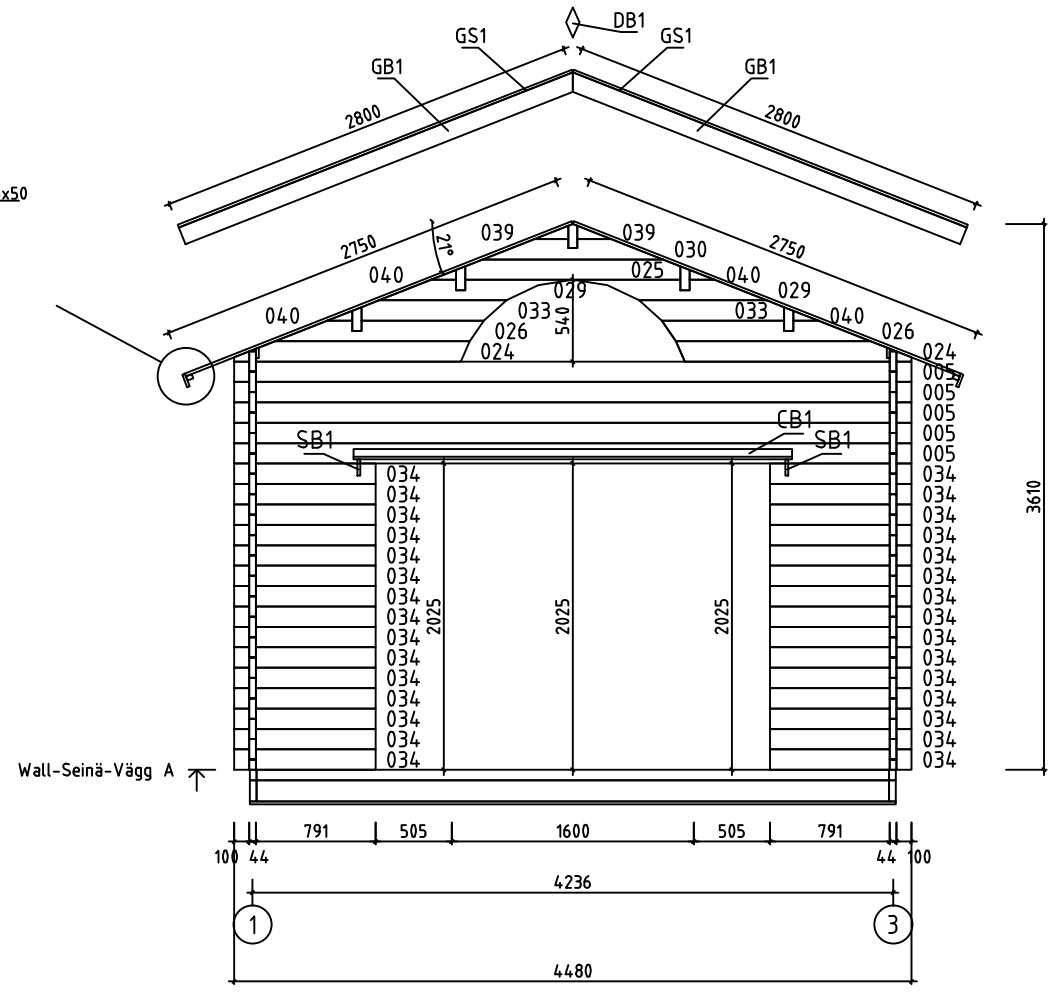
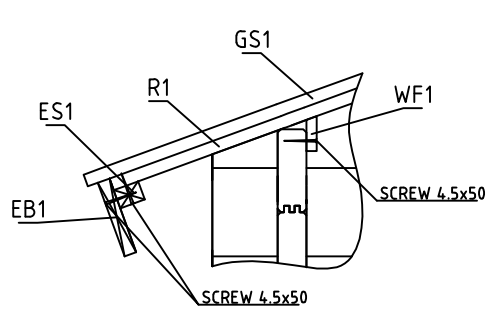



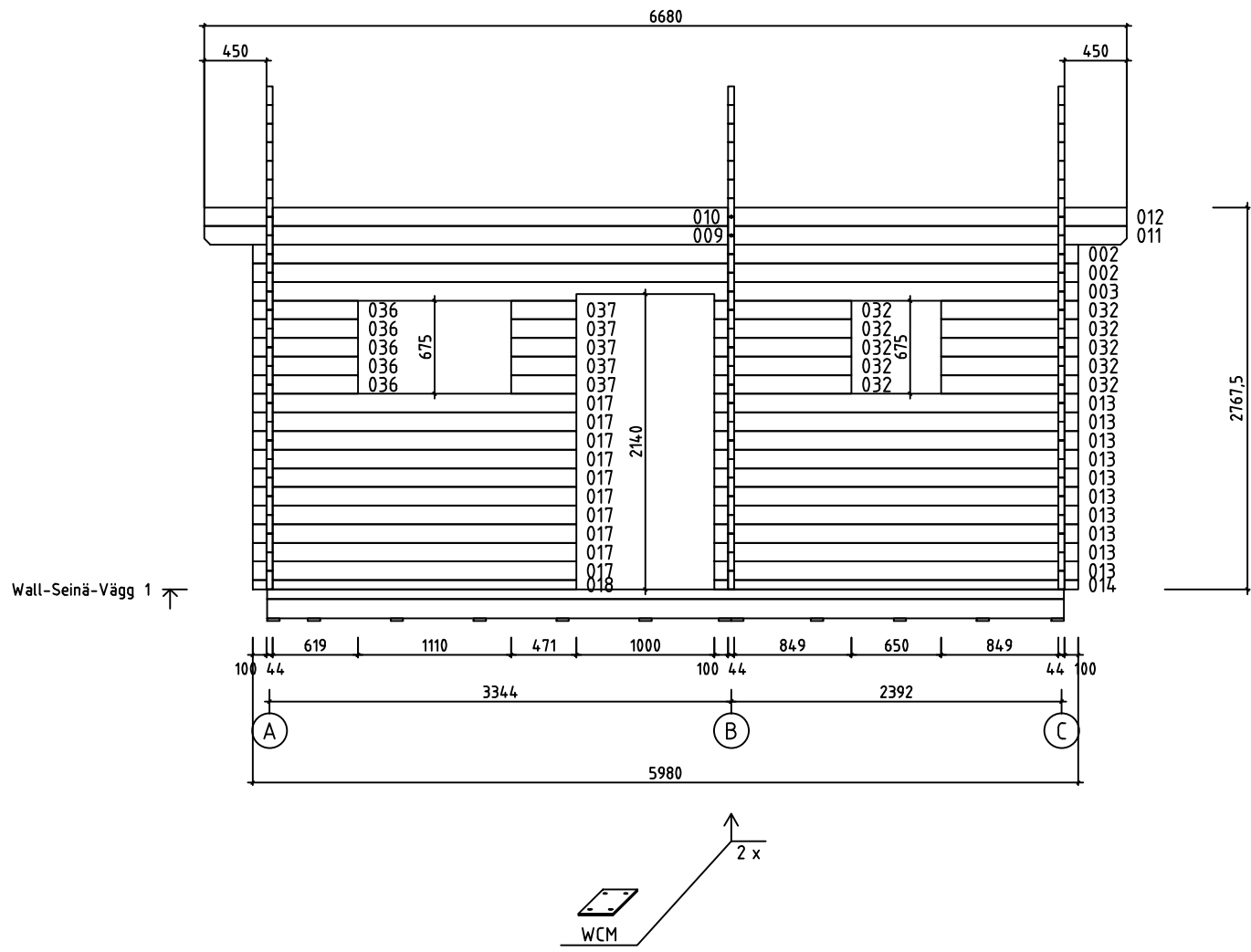



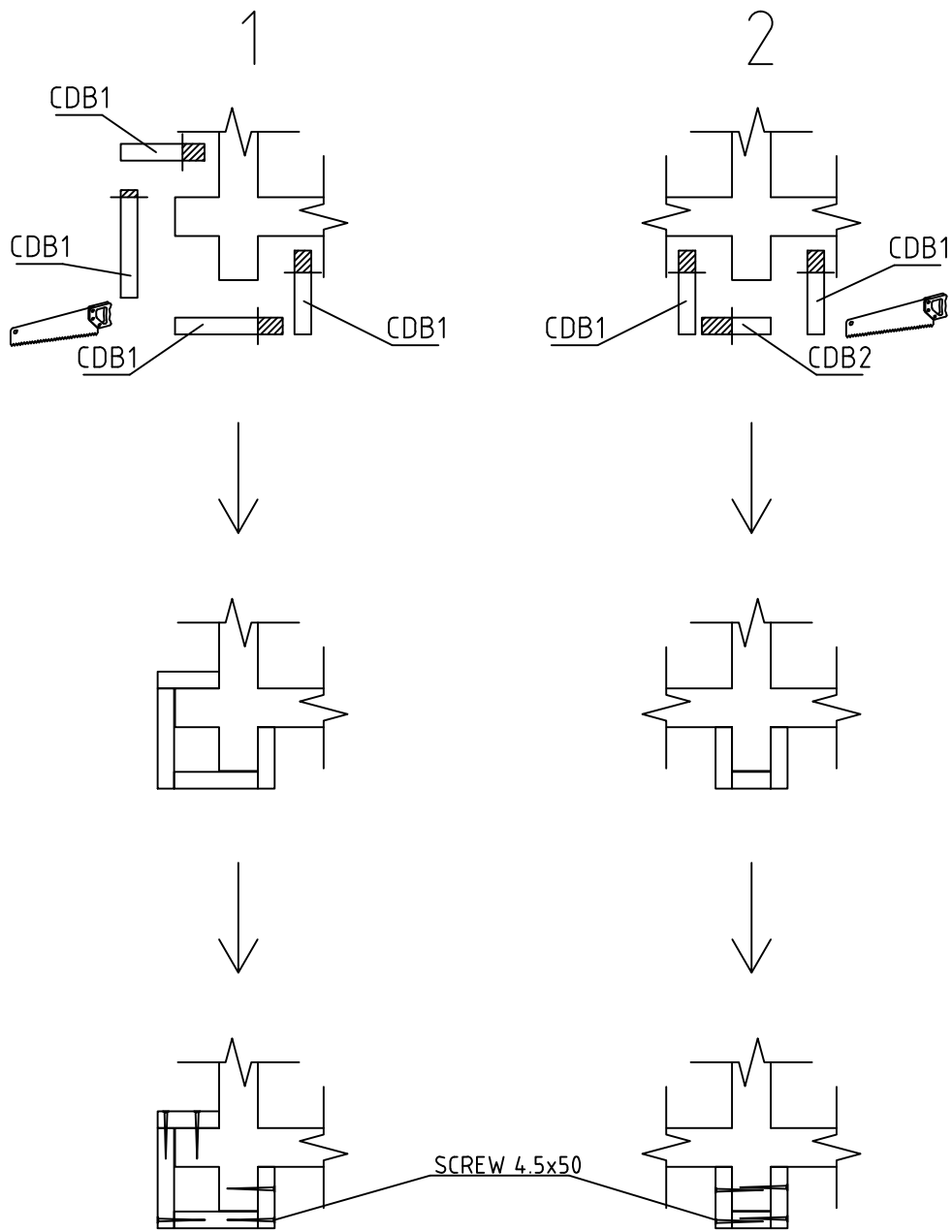
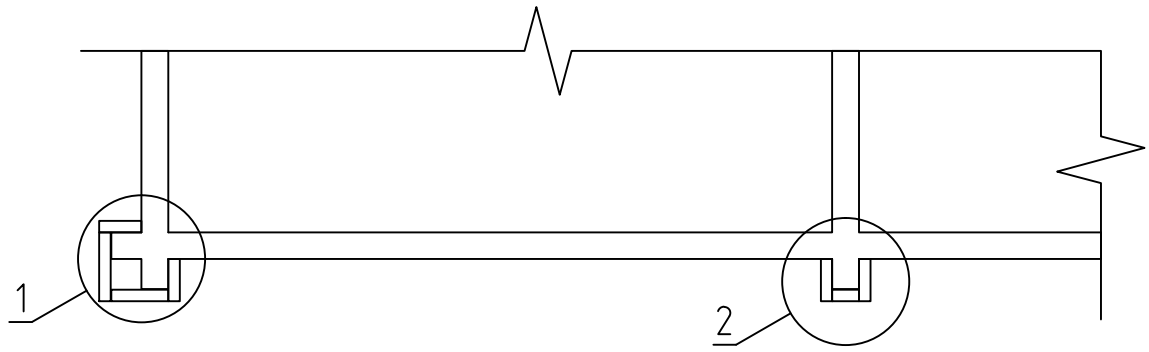

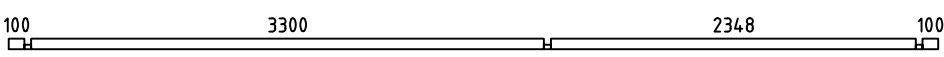
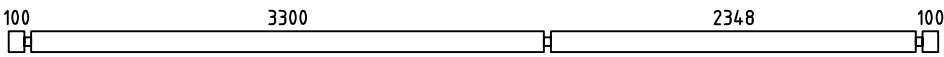
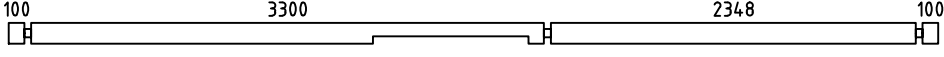
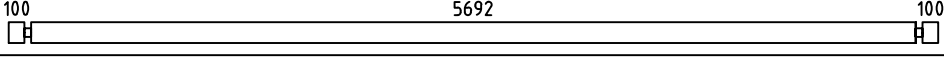
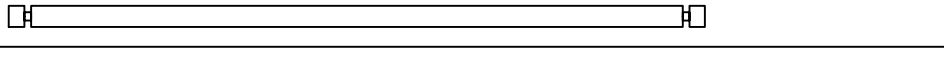
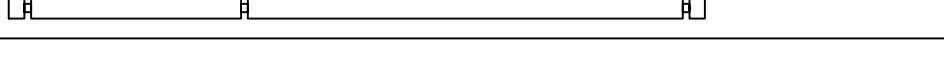
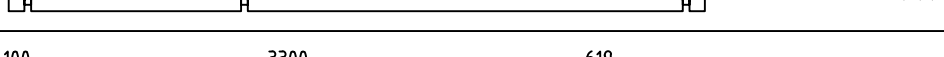
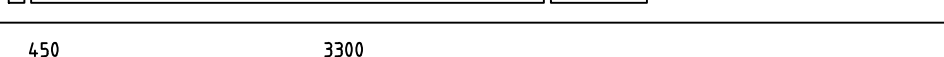
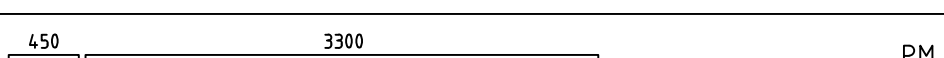
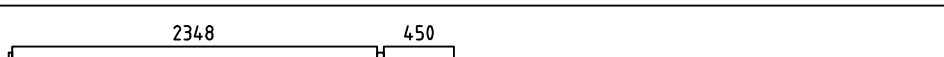

House	P5843-44 Olivia	Sheet	7
Drawing	WALL-SEINÄ-VÄGG A	Scale	1:50
Material	44x135	Date	05.01.2017
Drawer	RP	File	P5843-44 Olivia.dwg



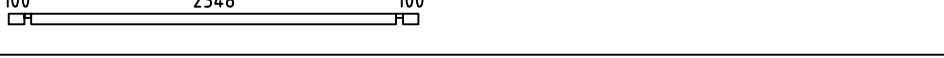
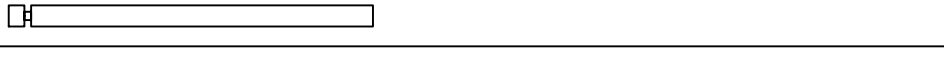
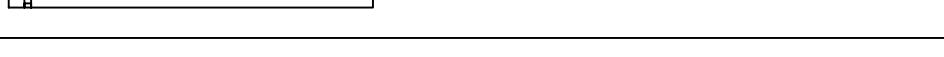
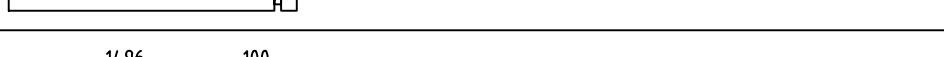
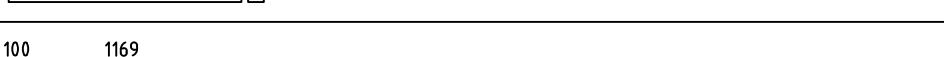
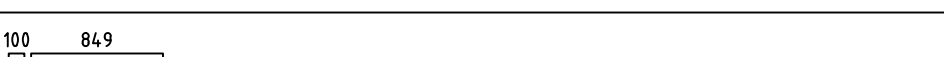
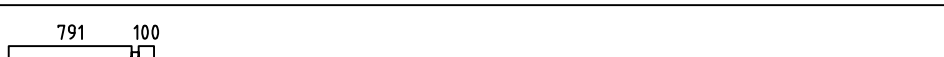



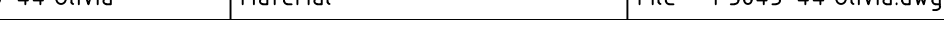

House	P5843-44 Olivia	Sheet	10
Drawing	WALL-SEINÄ-VÄGG 1	Scale	1:50
Material	44x135	Date	05.01.2017
Drawer	RP	File	P5843-44 Olivia.dwg

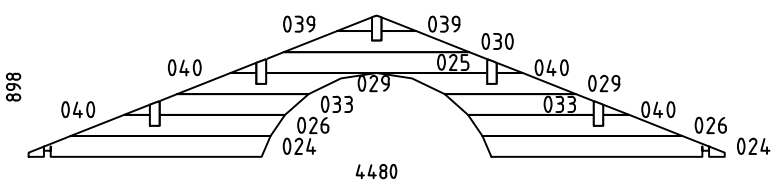
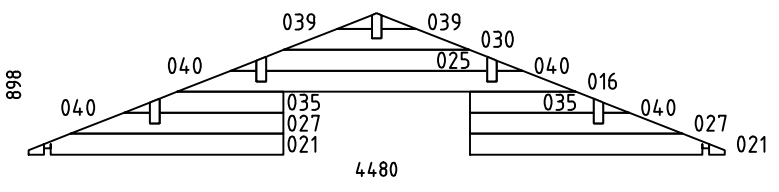
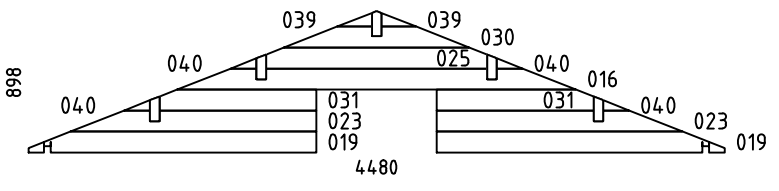

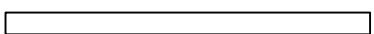
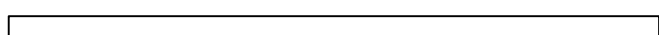
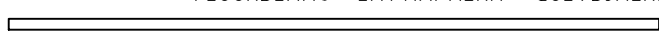
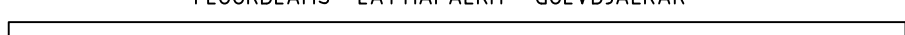
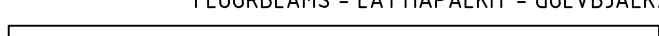
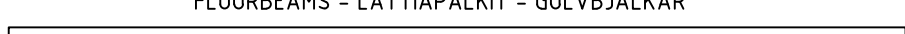
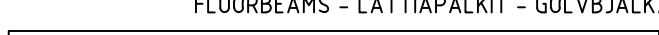



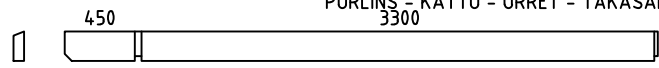
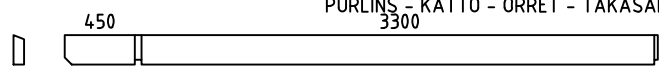
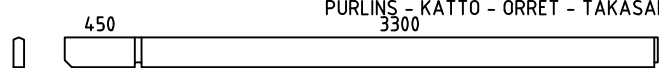
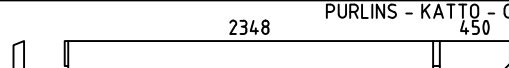
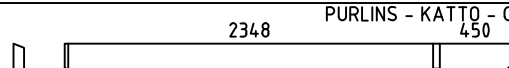

House	P5843-44 Olivia	Sheet	14
Drawing	CORNER DECORATION - HÖRN DEKORATION	Scale	1:50
Material		Date	05.01.2017
Drawer	RP	File	P5843-44 Olivia.dwg

Pos	P5843-44 Olivia	Pcs. St.	Profil(e) (mm)	L (mm)
001		1	44x68	5980
002		15	44x135	5980
003		1	44x135	5980
004	SPARE BEAM - VARALLAPALKI - RESERVDEL 	1	44x135	5980
005		6	44x135	4480
006		18	44x135	4480
007		PM 1	44x135	4480
008		5	44x135	4107
009		2	44x135	3816
010		PM 2	44x135	3816
011		2	44x135	2864
012		PM 2	44x135	2864
013		26	44x135	2636
014		2	44x68	2636
015		1	44x68	2636
017		10	44x135	2344
018		1	44x68	2344
020		4	44x135	1853
022		6	44x135	1640
028		15	44x135	1313
032		10	44x135	993
034		30	44x135	935
036		25	44x135	763
037		5	44x135	471
038		15	44x135	384

Pos	P5843-44 Olivia	Pcs. St.	Profil(e) (mm)	L (mm)
WA-1		1	44x898	4480
WB-1		1	44x898	4480
WC-1		1	44x898	4480
HB	HIT BLOCK-ASENNUSPALKI-SLAG BRÄDA 	2	44x135	300
LB1	LOFT FLOOR BEAMS-PARVIAPALKIT-LOFTBJÄLKAR 	11	43x140	2345
FB1	FLOORBEAMS - LATTIAPALKIT - GOLVBJÄLKAR 	2	70x140	4184
FB2	FLOORBEAMS - LATTIAPALKIT - GOLVBJÄLKAR 	2	70x70	4184
FB5	FLOORBEAMS - LATTIAPALKIT - GOLVBJÄLKAR 	2	43x140	5770
FB3	FLOORBEAMS - LATTIAPALKIT - GOLVBJÄLKAR 	10	43x140	4184
FB6	FLOORBEAMS - LATTIAPALKIT - GOLVBJÄLKAR 	2	43x70	5770
FB4	FLOORBEAMS - LATTIAPALKIT - GOLVBJÄLKAR 	10	43x70	4184
BB1	COUNTERFLOOR HOLDING BOARDS-ROSSIPOHJAA KANNATTELEVAT LAUDAT-BRÄDER SOM HALLER TROSSBOTTEN 	12	90x19	4270
FS2	SLEEPING FLOOR SUPPORTING SLAT-PARVIALATTIA TUKILISTA -LOFTGOLVLIST 	2	43x43	2795
FS1	SLEEPING FLOOR SUPPORTING SLAT-PARVIALATTIA TUKILISTA -LOFTGOLVLIST 	2	43x43	1345
RB5	PURLINS - KATTO - ORRET - TAKASAR  450 3300	2	68x190	3816
RB1	PURLINS - KATTO - ORRET - TAKASAR  450 3300	2	68x190	3816
RB3	PURLINS - KATTO - ORRET - TAKASAR  450 3300	1	68x190	3816
RB6	PURLINS - KATTO - ORRET - TAKASAR  2348 450	2	68x190	2864
RB2	PURLINS - KATTO - ORRET - TAKASAR  2348 450	2	68x190	2864
House	P5843-44 Olivia	Material	File	P5843-44 Olivia.dwg
			Sheet	16

Pos	P5843-44 Olivia		Pcs. St.	Profil(e) (mm)	L (mm)	
RB4	PURLINS - KATTO - ORRET - TAKASAR		1	68x190	2864	
F1	FLOORBOARD - LATTIALAUTA - GOLVBRÄDE		114 or-tai-eller 88	37+1 48+1	114x28 88x28	3295
F2	FLOORBOARD - LATTIALAUTA - GOLVBRÄDE		114 or-tai-eller 88	37+1 48+1	114x28 88x28	2340
L1	LOFT BOARD - PARVIALATTIA - LOFTGOLV		114 or-tai-eller 88	21+1 28+1	114x19 88x19	4185
R1	ROOFBOARD - KATTOLAUTA - TAKBRÄDE		114 or-tai-eller 88	118+2 154+2	114x19 88x19	2750
FF1	SKIRTING SLAT - LATTIALISTA - GOLVLIST				19x35	47 m
GB1	GABLE BOARD - KAAPELILAUTA - GAVELBRÄDA		4		19x120	2800
GS1	BOARD MATCHING WITH GABLE BOARD-KAAPELILAUTA VASTAVA LAUTA-BRÄDA OVANPÅ GAVELBRÄDA		4		19x70	2800
EB1	EAVE BOARD - RÄYSTÄSLAUTA - TAKFOTBRÄDE		4		19x90	3340
ES1	EAVE SLAT - RÄYSTÄSLISTA - TAKFOTLIST		4		30x40	3340
DB1	DECORATIVE - KORISTE - PRYDNADS		2		19x90	200
CDB1	CORNER DECORATION BOARD- HÖRN DEKORATION BRÄDE		22		120x19	2790
CDB2	CORNER DECORATION BOARD- HÖRN DEKORATION BRÄDE		3		90x19	2790
WF1	SIDEWALL SKIRTING SLAT-KATTOLISTA-PÄÄDYT -TAKLIST-GAVLAR		2		19x70	3296
WF2	SIDEWALL SKIRTING SLAT-KATTOLISTA-PÄÄDYT -TAKLIST-GAVLAR		2		19x70	2344
WF3	SIDEWALL SKIRTING SLAT-KATTOLISTA-PÄÄDYT -TAKLIST-GAVLAR		4		19x70	448
CB1	COVERING BOARD-PEITELAUTA-HYLLBRÄDA		1		19x120	2900
SB1	SUPPORT BOARD-TUKILAUTA-KONSOL		2		19x79	155
SS1	STORM SLAT-MYRSKY LISTA-OVÄDER SPJÄLA		4		19x35	2700
SS2	STORM SLAT-MYRSKY LISTA-OVÄDER SPJÄLA		2		19x35	2020
RCM	ROOFBEAMS CONNECTING METAL-METALL FÖR SAMMANFOGNING AV TAKASAR-KATTO-ORRE YHTEENLITYSMETALLT		5		∅6	200
WCM	WALLBEAMS CONNECTING METAL-METALLPLATTA FÖR SAMMANFOGNING AV VÄGGEN BALKAR-SEINÄPALKKEJA METALLISET YHTEENLIITYMISLAATAT		4		25	25
	SCREWS-RUUVIT-SKRUVAR FOR-VARTEN-FÖR	SS1, SS2		18	∅6	50
	WASHER-ALUSLAATTA-BRICKA FOR-VARTEN-FÖR	SS1, SS2		18	∅6	
	NAILS-NAULAT-SPIKAR FOR-VARTEN-FÖR	FF1		110	∅2.0	40
	NAILS-NAULAT-SPIKAR FOR-VARTEN-FÖR	F1, F2, L1, R1, BB1		1600	∅2.5	60
House	P5843-44 Olivia		Material	File	P5843-44 Olivia.dwg	
				Sheet	17	

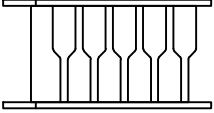
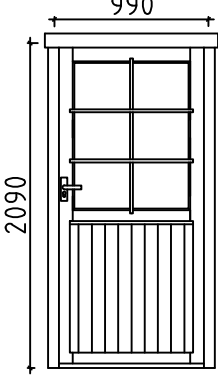
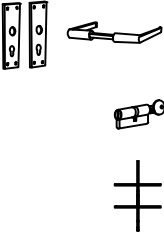
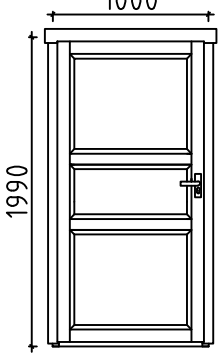
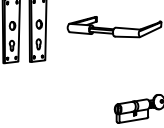
Pos	P5843-44 Olivia			Pcs. St.	Profil(e) (mm)	L (mm)
	SCREWS-RUUVIT-SKRUVAR FOR-VARTEN-FÖR	WCM		20	Ø3.5	35
	SCREWS-RUUVIT-SKRUVAR FOR-VARTEN-FÖR	GB1, GS1, EB1, ES1, DB1, CB CDB1, CDB2, WF1, WF2, WF3		300	Ø4.5	50
	SCREWS-RUUVIT-SKRUVAR FOR-VARTEN-FÖR	FS1, FS2, LB1, SB		50	Ø4.5	70
	SCREWS-RUUVIT-SKRUVAR FOR-VARTEN-FÖR	001, 014, 015, 018 FB1, FB2, FB3, FB4, FB5, FB6		70	Ø4.5	90
	SCREWS-RUUVIT-SKRUVAR FOR-VARTEN-FÖR	FB2, FB4, FB6		60	Ø5.0	120
	SCREWS-RUUVIT-SKRUVAR FOR-VARTEN-FÖR	RB1, RB2, RB3, RB4, RB5, RB6		20	Ø6.0	160
LD1	LADDER-TIKAPUUT-STEGE			1	700	2760
D1	DOOR-OVI-DÖRR (right-oikea-höger) ORT_ST 		P	1	990	2090
D2	DOOR-OVI-DÖRR (left-jäljellä-vänster) AST 		V	2	1000	1990
House P5843-44 Olivia		Material	File P5843-44 Olivia.dwg	Sheet 18		

Pos	P5843-44 Olivia	Pcs. St.	Profil(e) (mm)	L (mm)
D3	DÖRR-OVI-DÖRR (right-oikea-höger) ORT_ST	P 1	1600	1990
W1	WINDOW-IKKUNAN-FÖNSTER ORT_ST_K 	2 1 1 1	500	1990
W2	WINDOW-IKKUNAN-FÖNSTER ORT_ST_SU 	2 2 2 2	1100	640
W3	WINDOW-IKKUNAN-FÖNSTER (right-oikea-höger) ORT_ST 	P 1 1 1 1	640	640
W4	WINDOW-IKKUNAN-FÖNSTER ORT_ST_SU 	1 1 1 1	765	640
W5	WINDOW-IKKUNAN-FÖNSTER ORT_ST_K 	1	1420	510
FL1	FRAME AROUND LOFT ENTRANCE 	1	1190	780

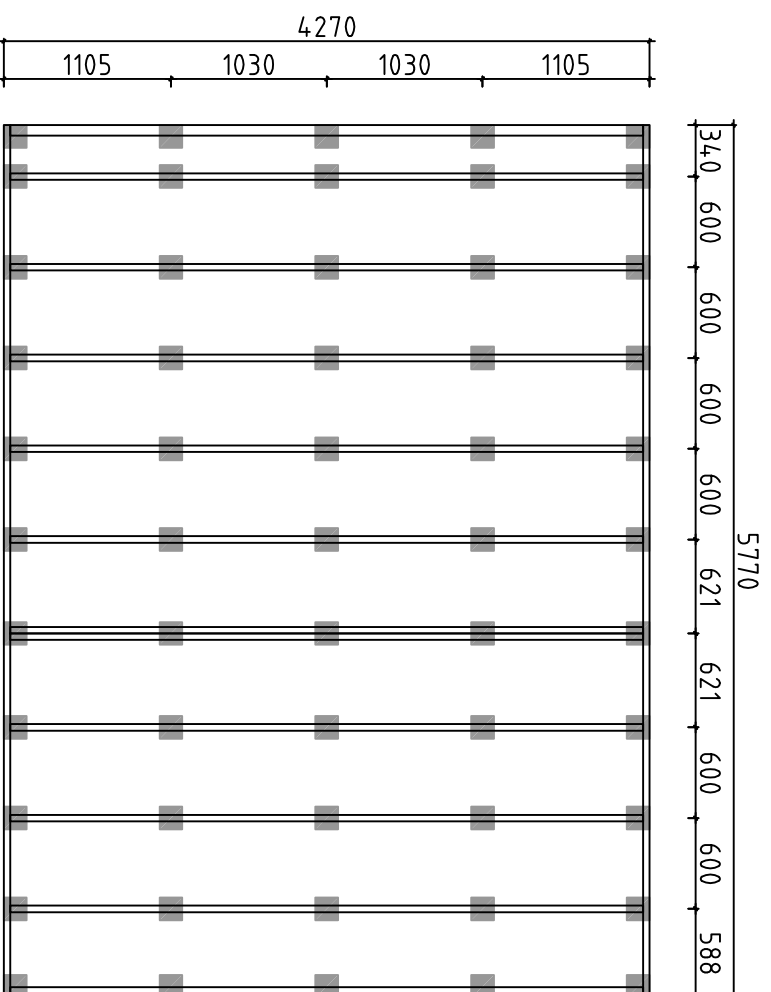

Detta är ett förslag för hur man kan placera plintarna (100-200 mm i diameter) för golvbjälklaget. Golvbjälkarna är med i byggsatsen, men inte plintarna. Använder man exempelvis 500-600mm långa murblock så kan man halvera antalet punkter. Lägg fuktskyddande papp mellan betong och trä

Tämä on ehdotus siitä, miten (100-200 mm läpimittaiset) jalat voidaan sijoittaa alapohjaa varten. Lattiapalkit ovat rakennussarjassa, mutta jalkoja ei ole. Kun käytetään esimerkiksi 500-600 mm pitkiä harkkoja, voidaan pisteiden määrä puoltaa. Aseta betonin ja puun väliin kosteudelta suojaava pähvi

A proposal for placing plinths (100-200 mm in diameter) for floor beams. Floor beams are provided in the kit but plinths are not included. For example, by using 500-600 mm long masonry units, one can reduce the number of points 50%. Place cardboard between the concrete and wood to protect from moisture

House	P5843-44 Olivia	Sheet	20
Drawing	PLINTPLAN - FOUNDATION PLAN	Scale	1:50
Material		Date	05.01.2017
Drawer	RP	File	P5843-44_Olivia_Foundation.dwg

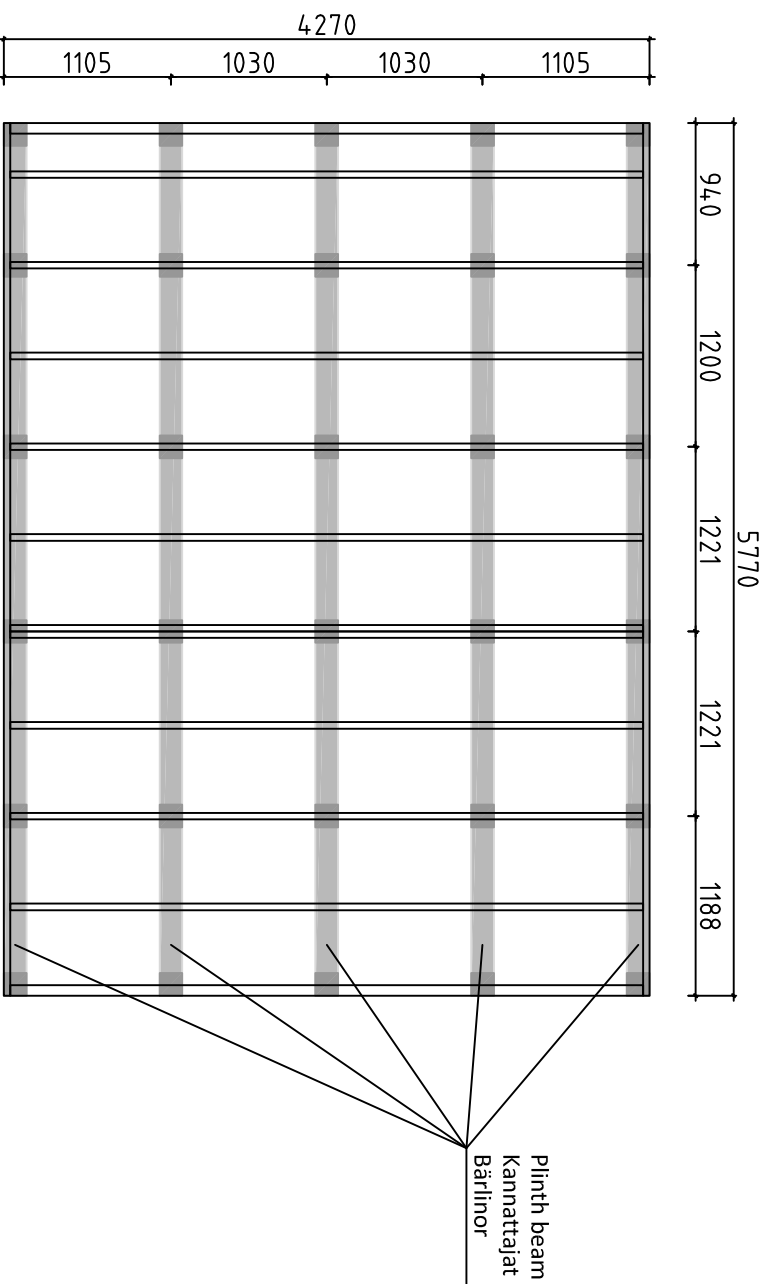

Förslag på alternativ plintplan med bärlnor och plintar. Bärlnor 45x95 eller 45x120 och plintar ca 100-200 mm i diameter. (Bärlnor och plintar ingår ej i leveransen). Används exempelvis murblock, (ingår ej i leveransen) istället för plintar, kan man lägga bärlnorna platt mot dessa och på det sättet minska höjden på konstruktionen. I denna konstruktion kan man dessutom lägga en "boardskiva" mellan bärlnorna och golvbjälkarna och på det sättet bära upp bjälklagsisoleringen. Lagg fuktskyddande papp mellan betong och trä

Endotus valtoehtoisesesta jalustasta kannattajilla ja jalolla. Kannattajat 45x95 tai 45x120 ja jalat läpimitataan n. 100-200 mm (kannattajat ja jalat ei ole toimituksessa). Käytettäessä esimerkiksi harkkoja (ei kuulu toimitukseen) jalkojen sijasta, voi kannattajat asettaa lappeelleen niitä vasten ja sillä tavoin vähentää rakenteen korkeutta. Tässä rakenteessa voi lisäksi asettaa levyä kannattajien ja lattiapalkkien väliin ja sillä tavoin kannattaa alapohjan eristystä. Aseta betonin ja puun väliin kosteudelta suojaava pähvi

A proposal for alternative plinth beam layout plan. Plinth beams 45x95 or 45x120 and plinths ca 100-200 mm in diameter (plinth beams and plinths are not included in the kit). For example, by using masonry units (not included in the kit) instead of plinths, one can lay plinth beams flat against the masonry units and in that way reduce the height of the structure. In this construction one can also add "plywood board" between plinth beams. Place cardboard between the concrete and wood to protect from moisture

House	P5843-44 Olivia	Sheet	21
Drawing	PLINTPLAN - FOUNDATION PLAN	Scale	1:50
Material		Date	05.01.2017
Drawer	RP	File	P5843-44_Olivia_Foundation.dwg

#001	3	5980	1
#002	1,3	5980	15
#003	1	5980	1
#004		5980	1
#005	A,C	4480	6
#006	B,C	4480	18
#007	B	4480	1
#008	3	4107	5
#009	1,3	3816	2
#010	1,3	3816	2
#011	1,3	2864	2
#012	1,3	2864	2
#013	1,2	2636	26
#014	1,2	2636	2
#015	2	2636	1
#016	B,C	2565	2
#017	1	2344	10
#018	1	2344	1
#019	C	1853	2
#020	C	1853	4
#021	B	1640	2
#022	B	1640	6
#023	C	1582	2
#024	A	1558	2
#025	A,B,C	1424	3
#026	A	1380	2
#027	B	1369	2
#028	B	1313	15
#029	A	1283	2
#030	A,B,C	1194	3
#031	C	1011	2
#032	1	993	10
#033	A	960	2
#034	A	935	30
#035	B	798	2
#036	1,3,B	763	25
#037	1	471	5
#038	B	384	15
#039	A,B,C	224	6
#040	A,B,C	168	12