

Date rev. Description

House	P584.3-70 Jack	Sheet	1
-------	----------------	-------	---

Drawing	3D	Scale	
---------	----	-------	--

Material	70x135	Date	05.01.2017
----------	--------	------	------------

Drawer	RP	File	P584.3-70 Jack 3D.dwg
--------	----	------	-----------------------

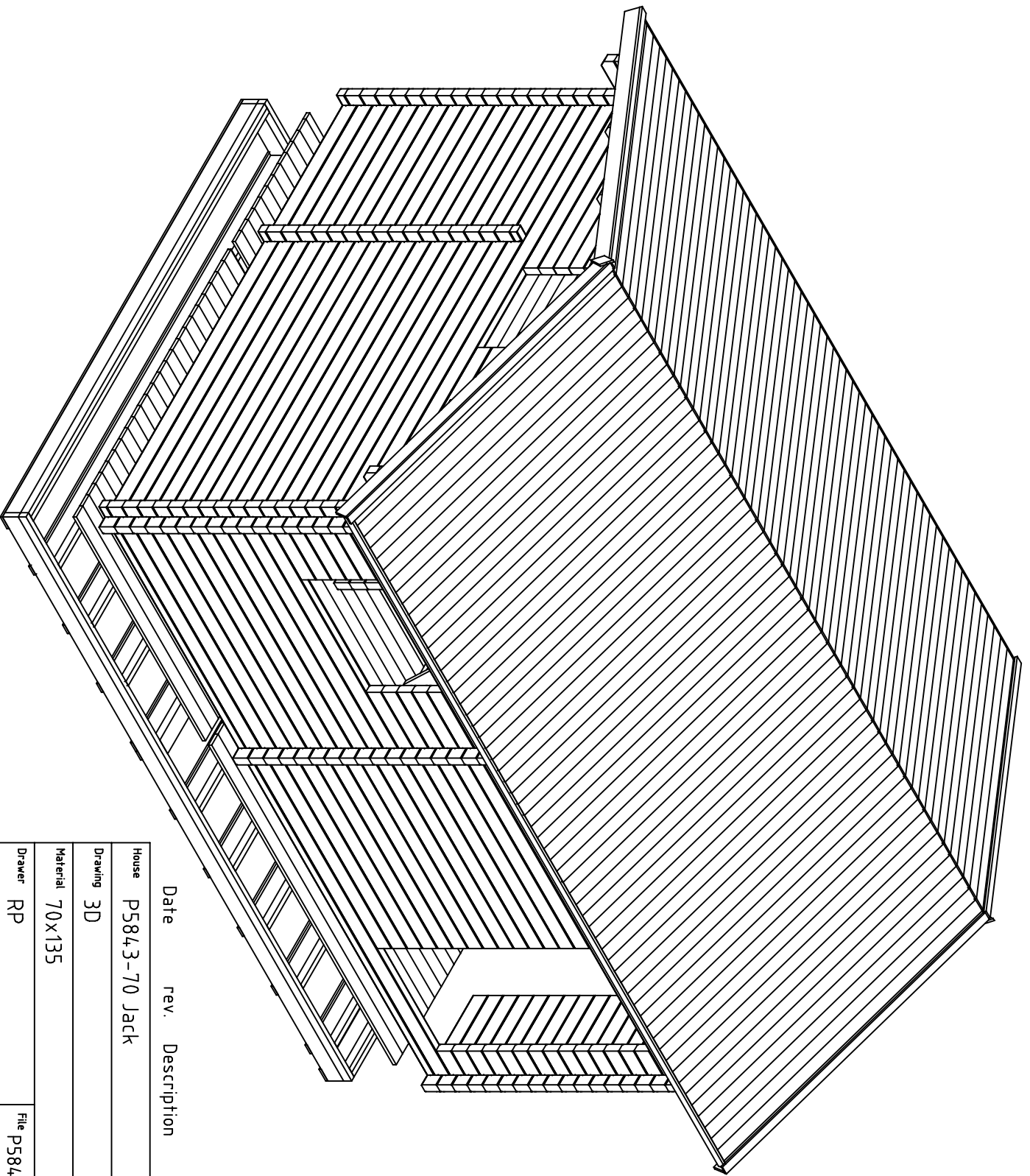

Date rev. Description

House	P5843-70 Jack	Sheet	2
-------	---------------	-------	---

Drawing	3D	Scale	
---------	----	-------	--

Material	70x135	Date	05.01.2017
----------	--------	------	------------

Drawer	RP	File	P5843-70 Jack 3D.dwg
--------	----	------	----------------------

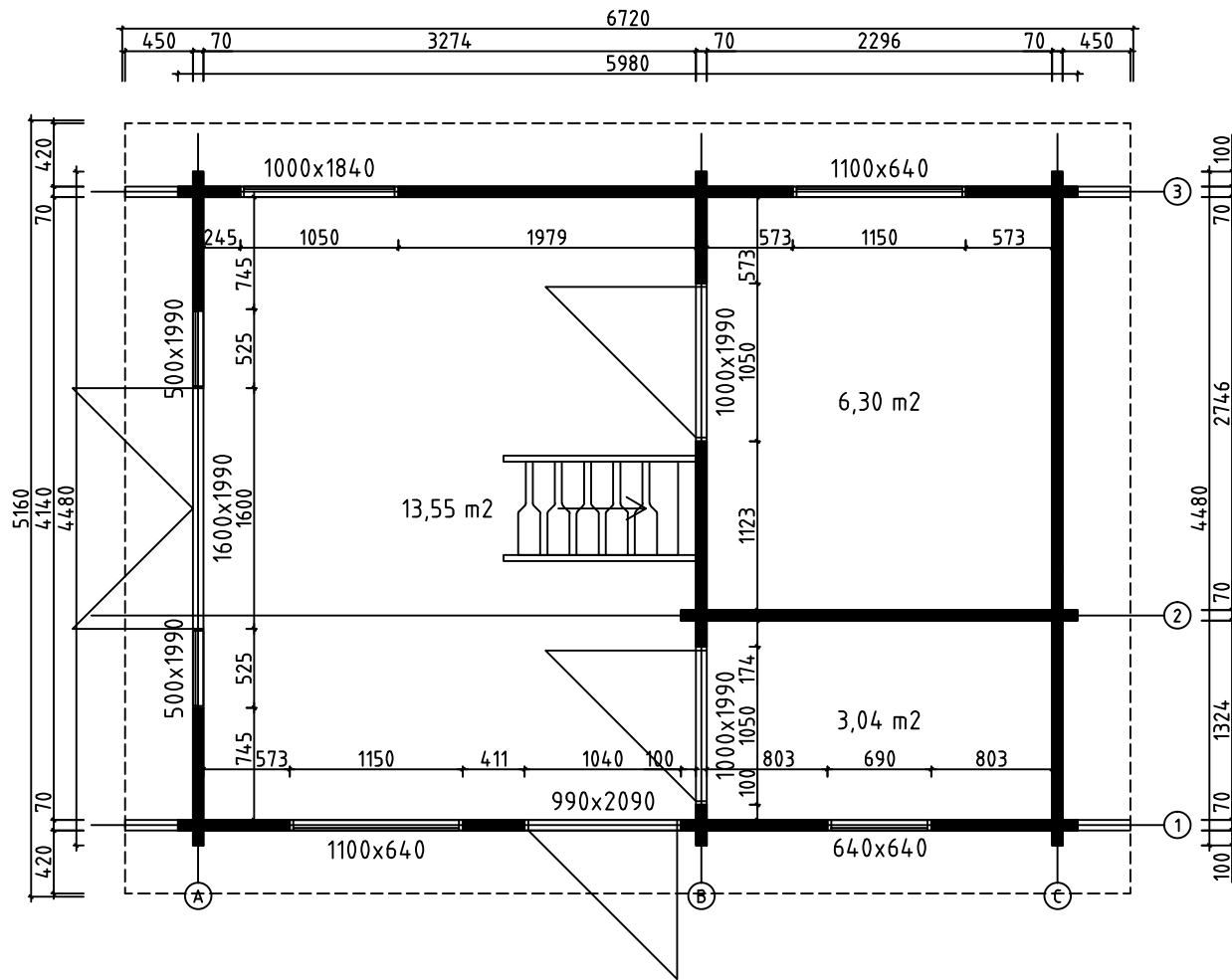

House	P5843-70 Jack	Sheet	3
Drawing	PLAN-SUUNNITELMA-PLANEN	Scale	1:50
Material	70x135	Date	05.01.2017
Drawer	RP	File	P5843-70 Jack.dwg

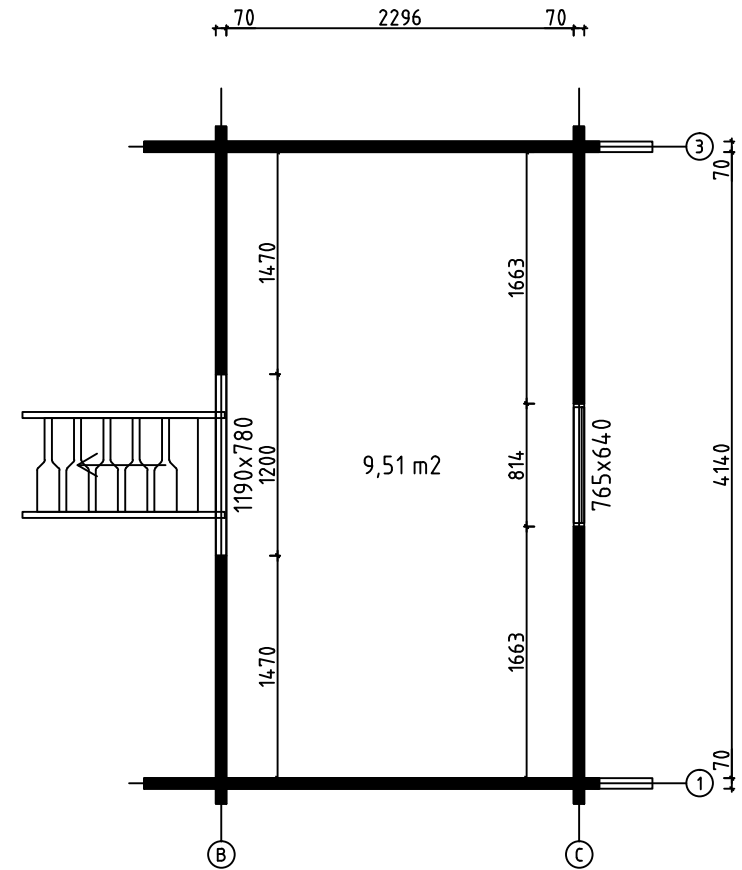
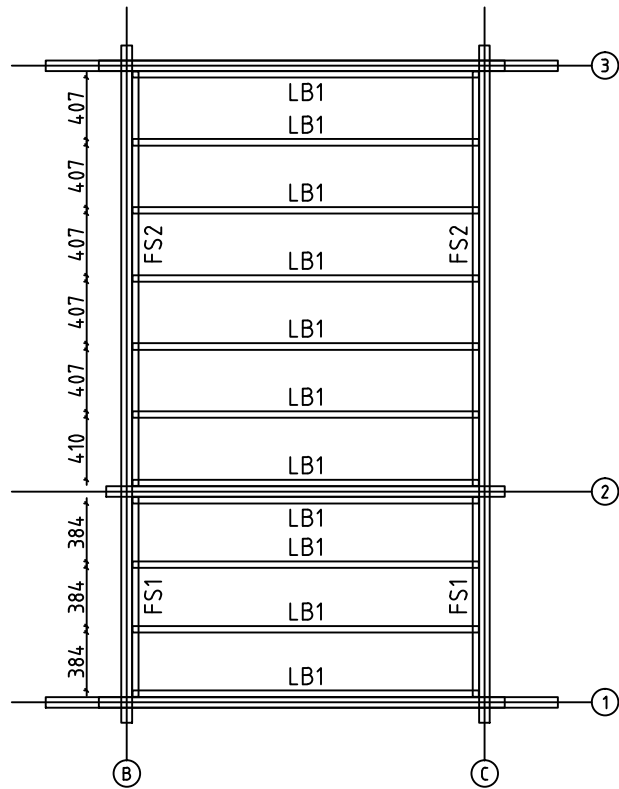

LOFT FLOOR BEAMS - PARVIA LATTIAPALKIT - LOFT GOLVBJÄLKAR

House	P5843-70 Jack	Sheet	4
Drawing	LOFT FLOOR - PARVIA LATTIA - LOFT GOLV	Scale	1:50
Material	43x43, 43x140 70x135	Date	05.01.2017
Drawer	RP	File	P5843-70 Jack.dwg

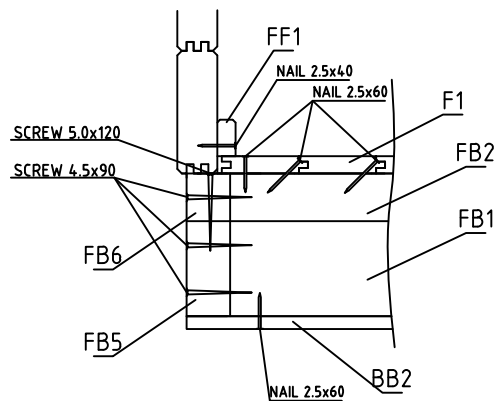
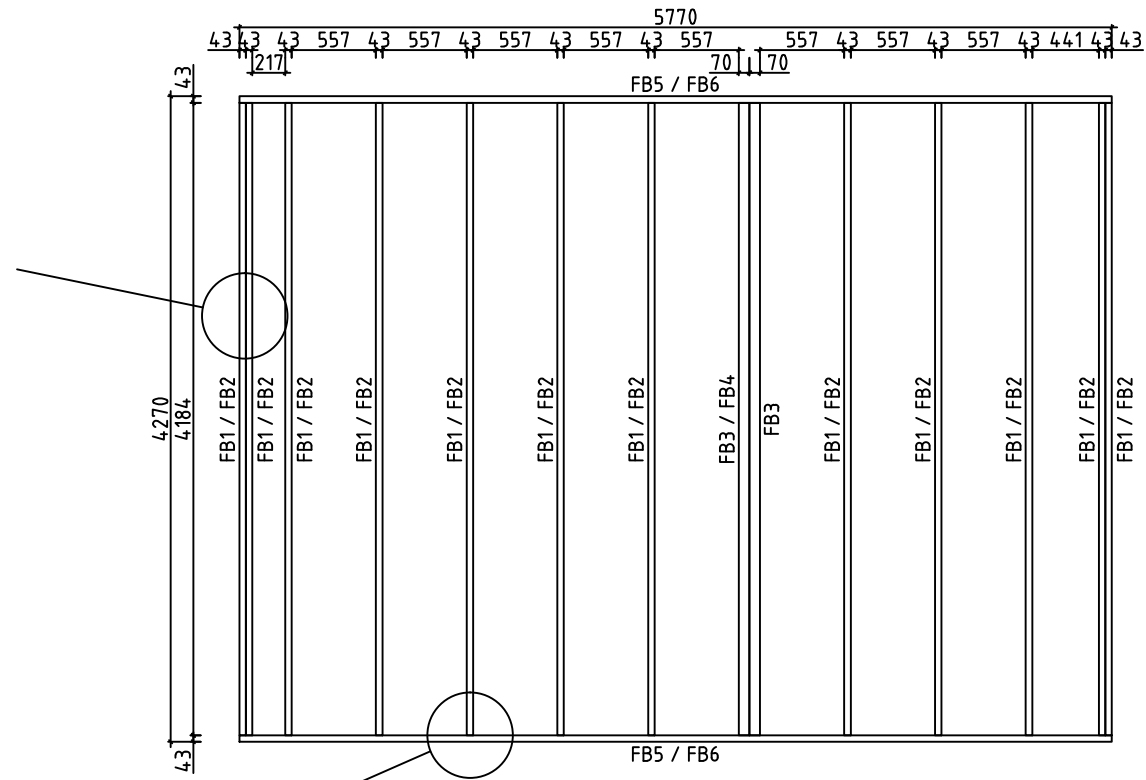
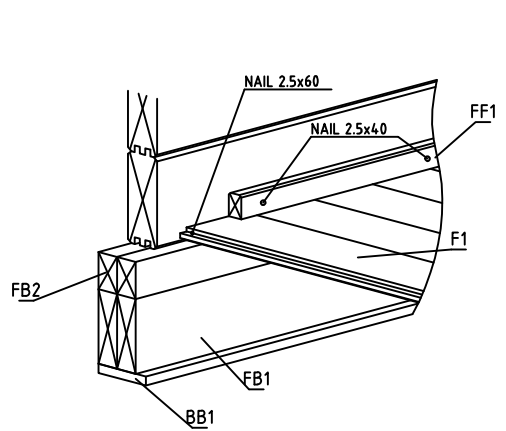

House	P5843-70 Jack	Sheet	5
Drawing	FLOORBEAMS-LATTIAPALKIT-GOLVBJÄLKAR	Scale	1:50
Material	70x140, 43x140, 43x70	Date	05.01.2017
Drawer	RP	File	P5843-70 Jack.dwg

F1

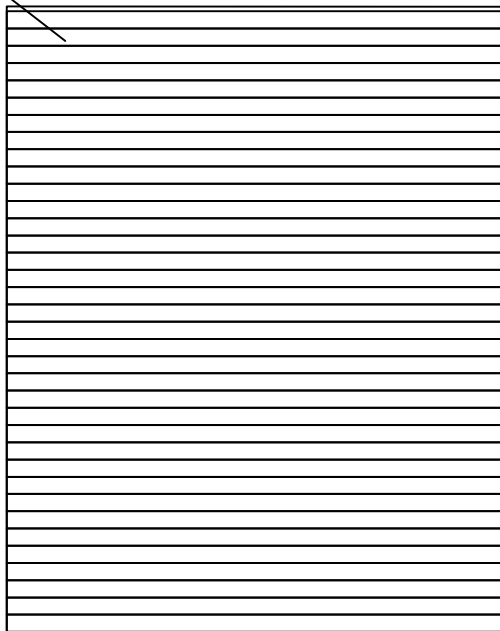

F2

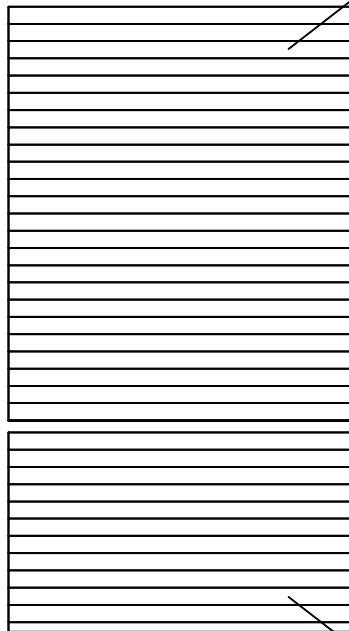

F2

FLOORBOARD-LATTIALAUTA-GOLVBRÄDE (114x28)

L1

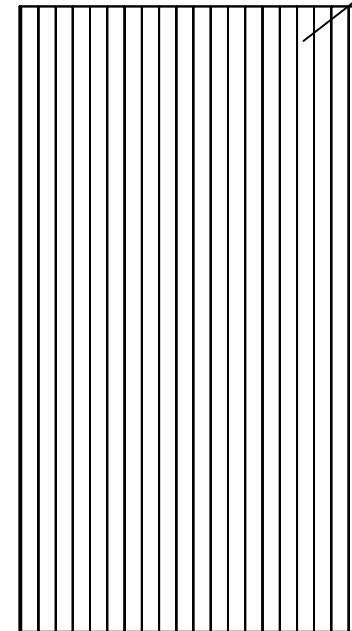

LOFT FLOORBOARD - PARVIA LATTIALATTIA - LOFT GOLVBRÄDE (114x19)

House	P5843-70 Jack	Sheet	6
Drawing	FLOORBOARD-LATTIALAUTA-GOLVBRÄDE	Scale	1:50
Material	114x28, 114x19	Date	05.01.2017
Drawer	RP	File	P5843-70 Jack.dwg

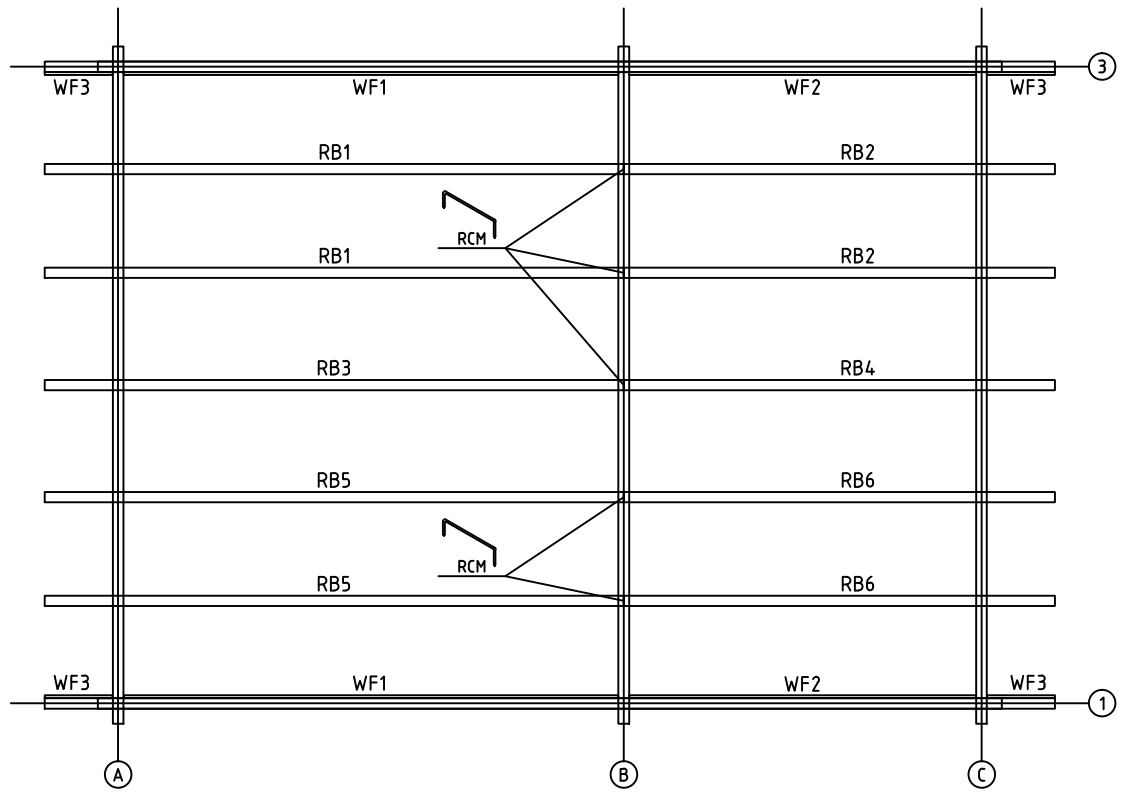

House	P5843-70 Jack	Sheet	7
Drawing	PURLINS-KATTO-ORRET-TAKÅSAR	Scale	1:50
Material	68x190, 19x90	Date	05.01.2017
Drawer	RP	File	P5843-70 Jack.dwg

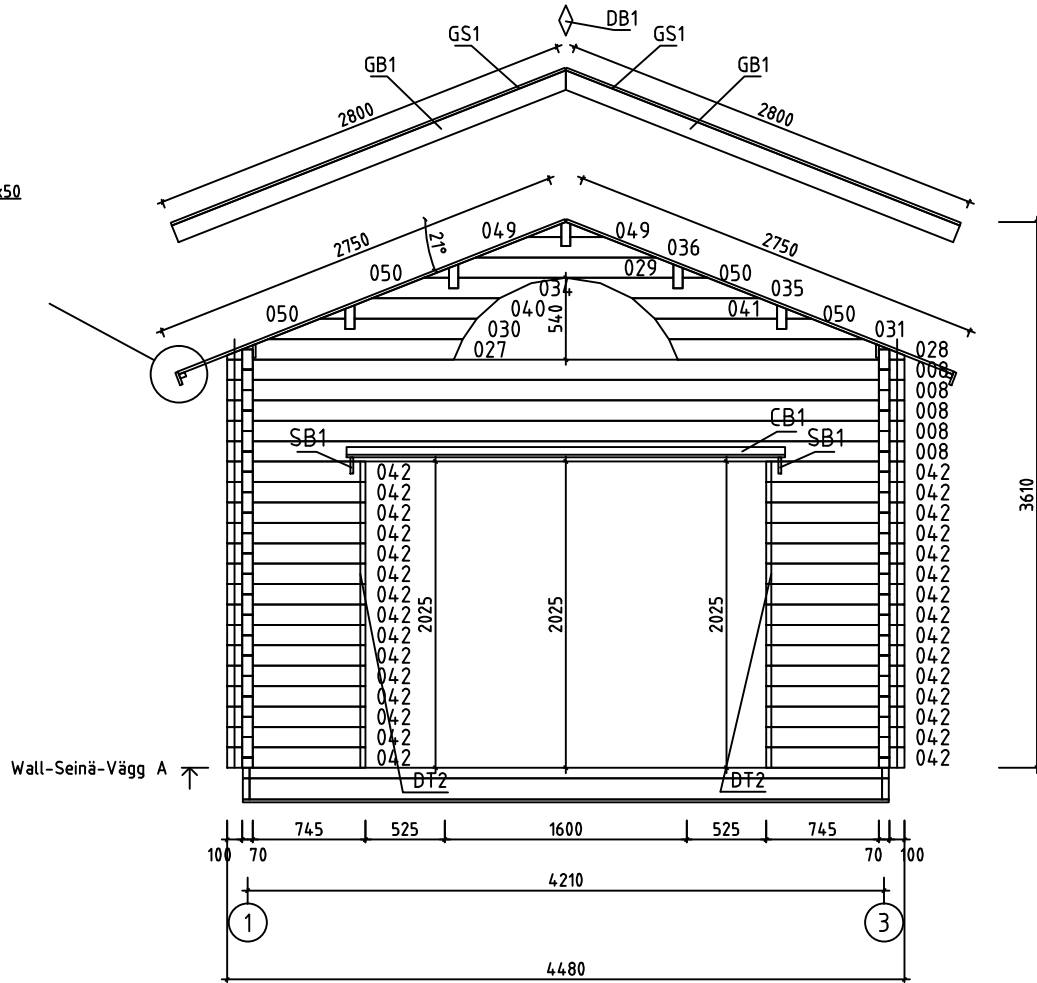
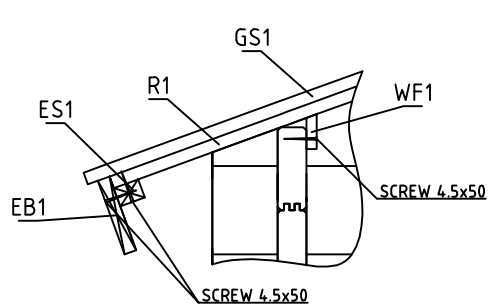

Wall-Seinä-Vägg A

House	P5843-70 Jack	Sheet	8
Drawing	WALL-SEINÄ-VÄGG A	Scale	1:50
Material	70x135	Date	05.01.2017
Drawer	RP	File	P5843-70 Jack.dwg



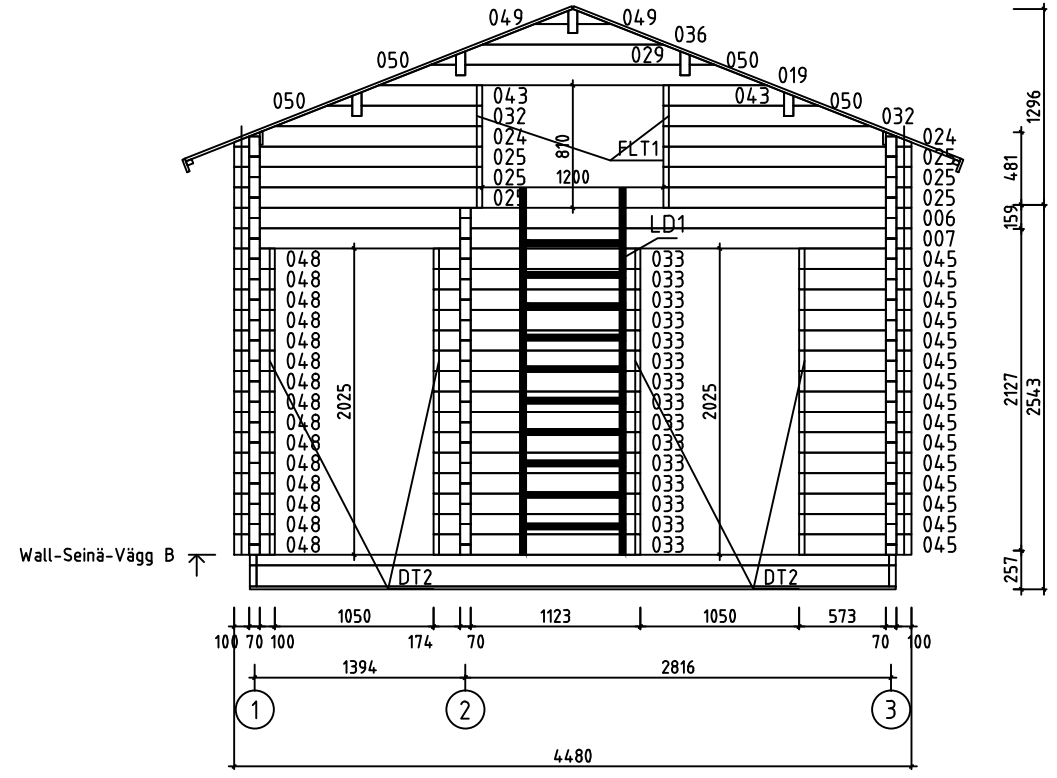

House	P5843-70 Jack	Sheet	9
Drawing	WALL-SEINÄ-VÄGG B	Scale	1:50
Material	70x135	Date	05.01.2017
Drawer	RP	File	P5843-70 Jack.dwg

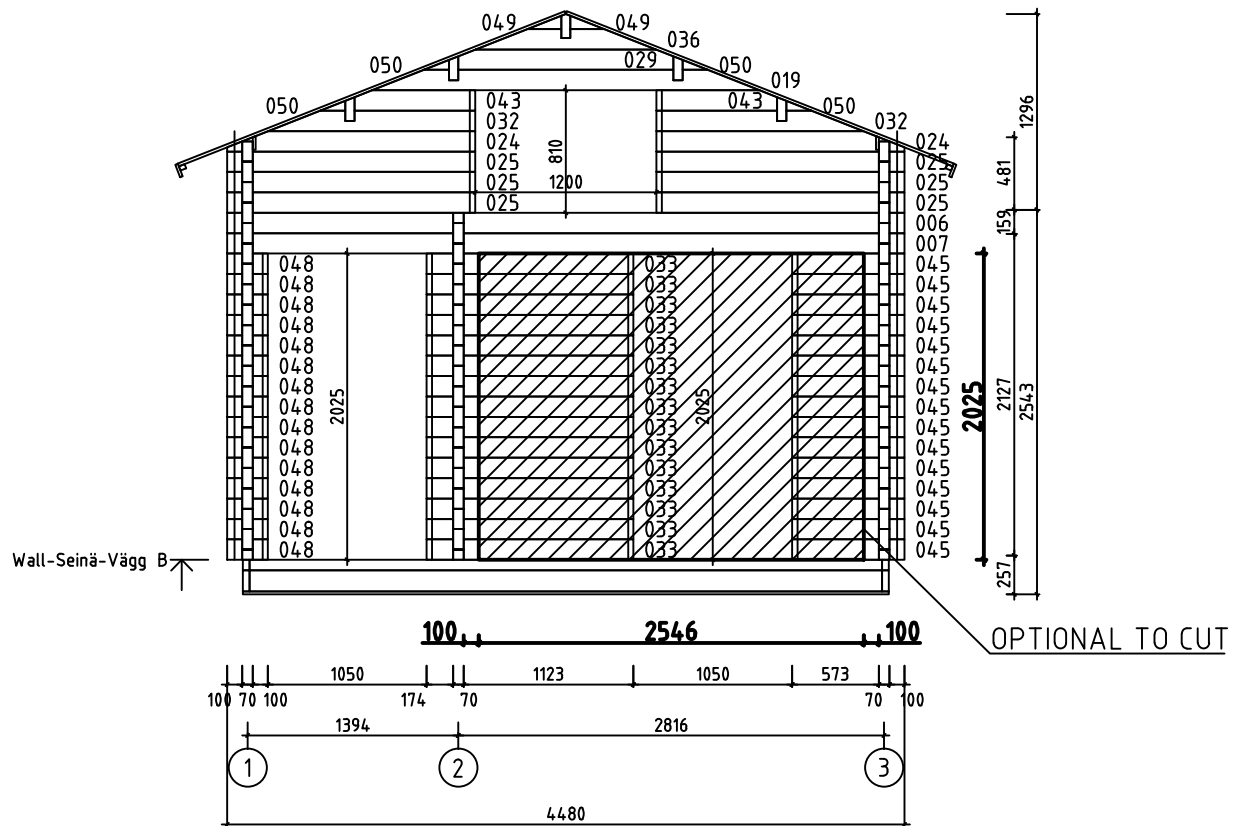

House	P5843-70 Jack	Sheet	9A
Drawing	WALL-SEINÄ-VÄGG B	Scale	1:50
Material	70x135	Date	05.01.2017
Drawer	RP	File	P5843-70 Jack Optional.dwg

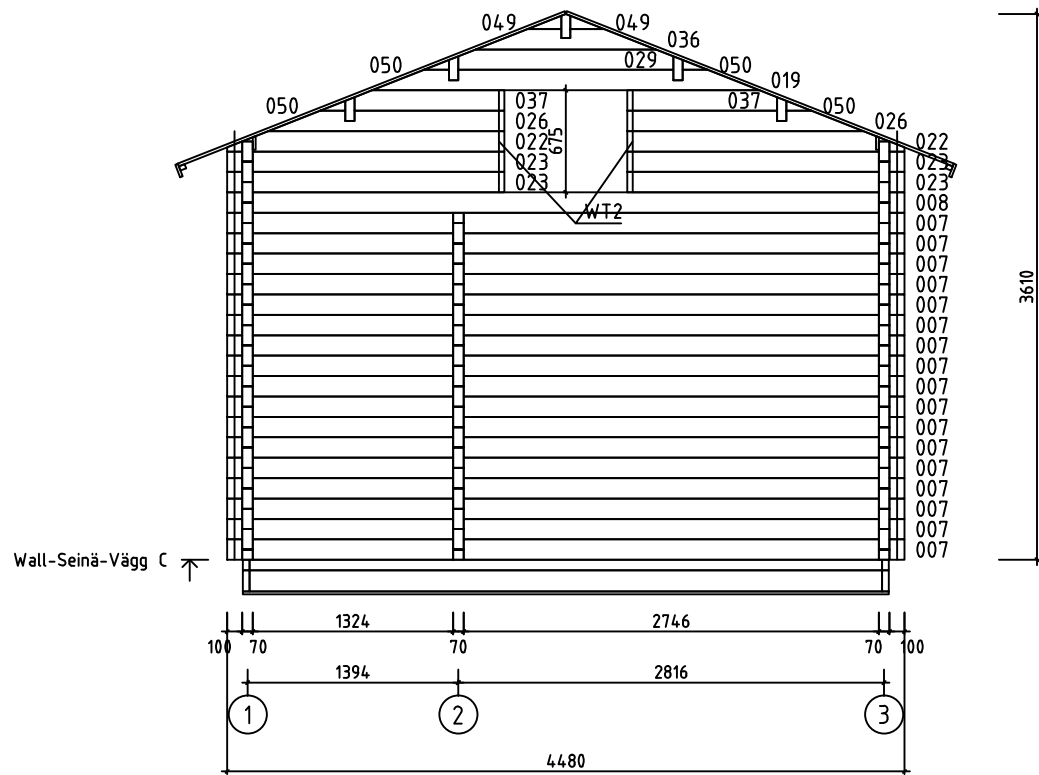

House	P5843-70 Jack	Sheet	10
Drawing	WALL-SEINÄ-VÄGG C	Scale	1:50
Material	70x135	Date	05.01.2017
Drawer	RP	File	P5843-70 Jack.dwg

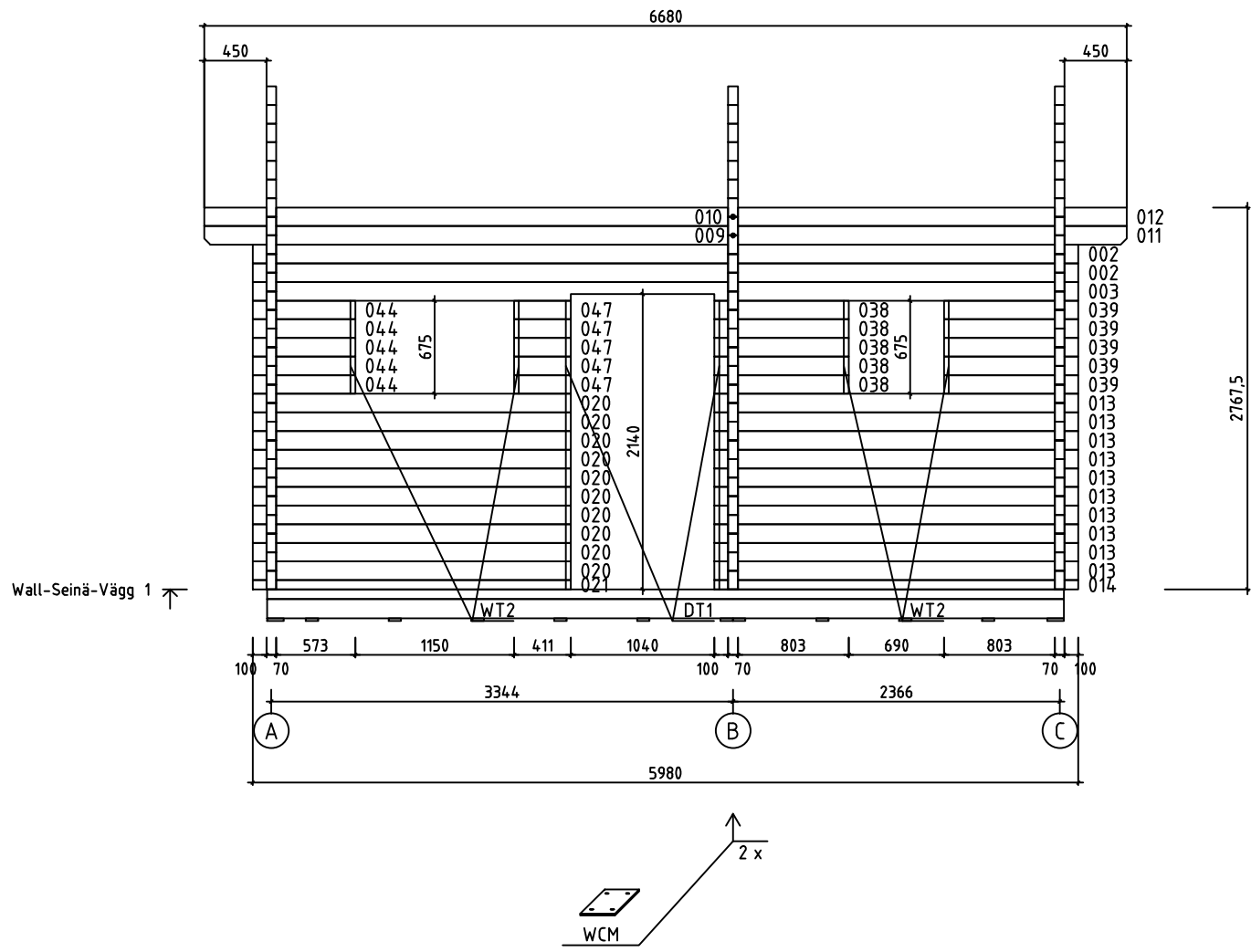

House	P5843-70 Jack	Sheet	11
Drawing	WALL-SEINÄ-VÄGG 1	Scale	1:50
Material	70x135	Date	05.01.2017
Drawer	RP	File	P5843-70 Jack.dwg

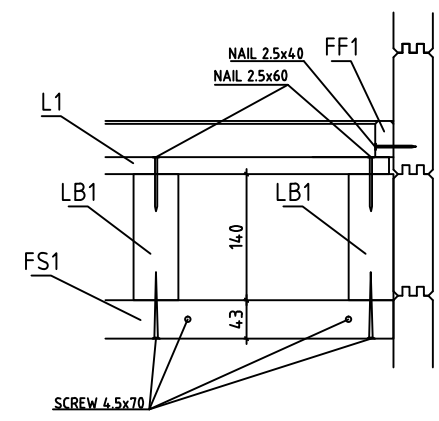
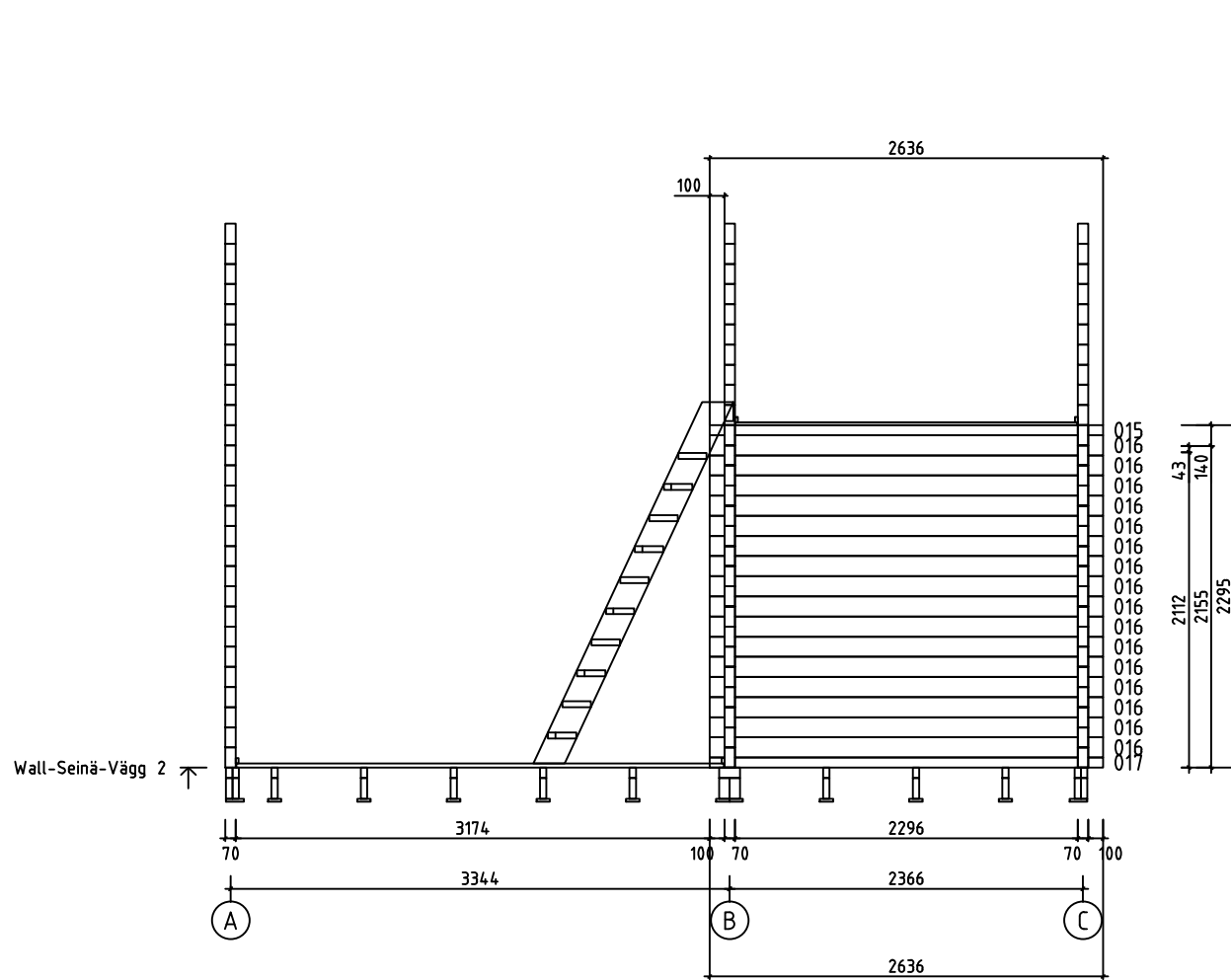



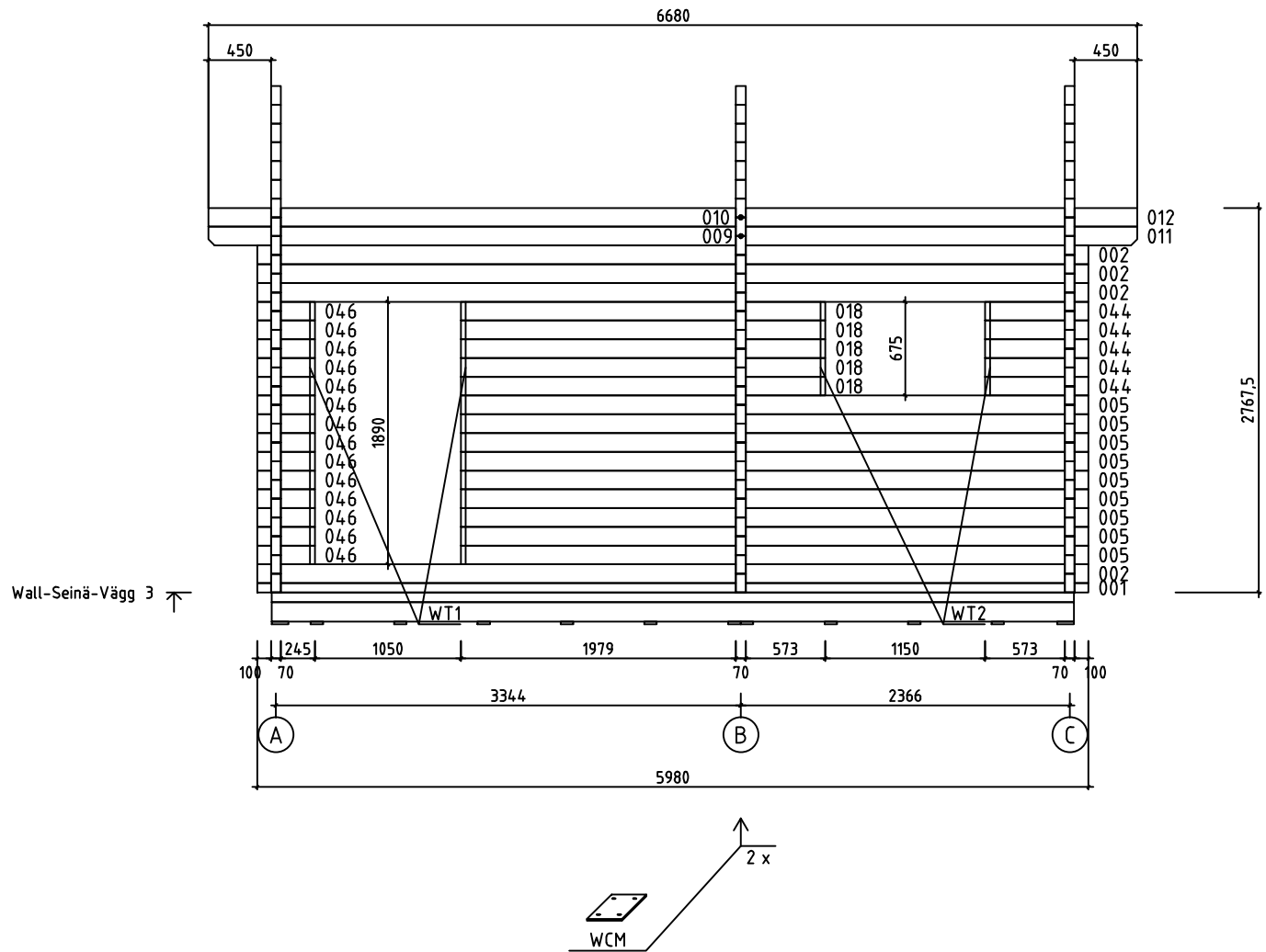

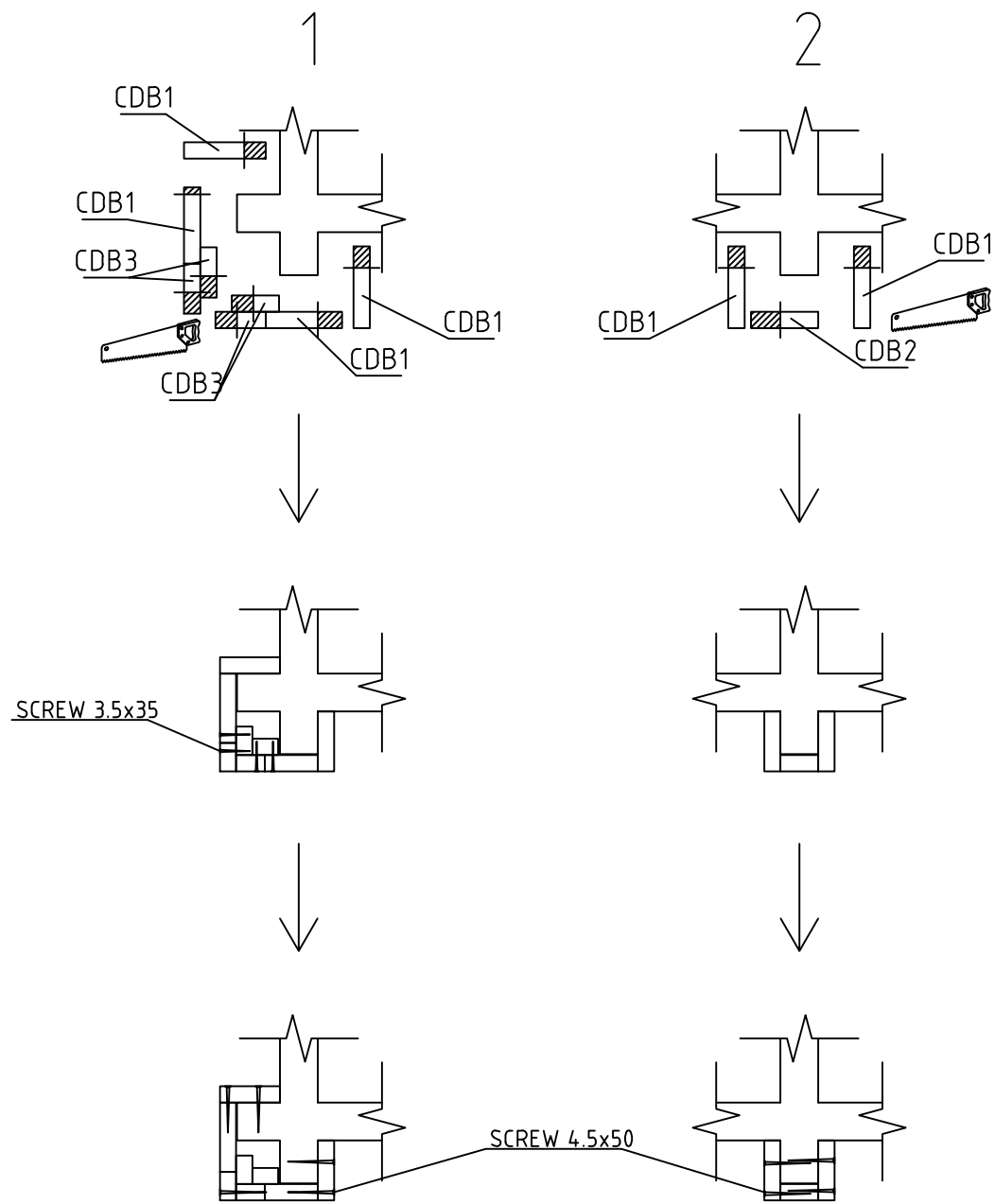
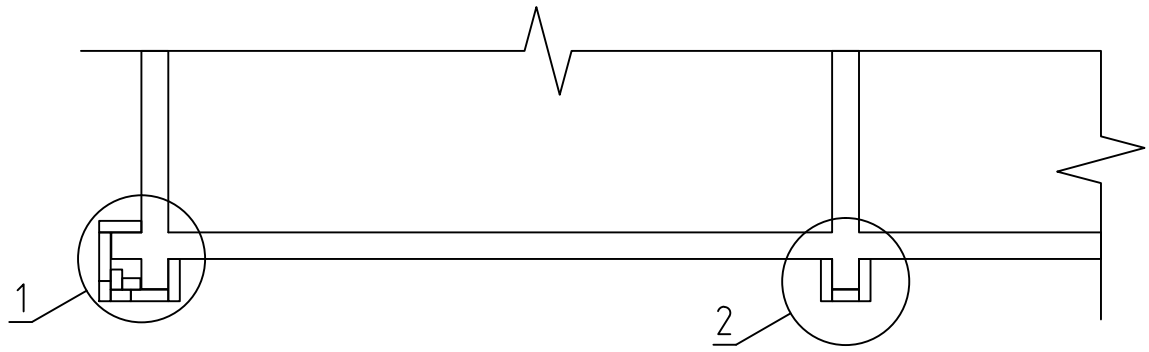

House	P5843-70 Jack	Sheet	12
Drawing	WALL-SEINÄ-VÄGG 2	Scale	1:50
Material	70x135	Date	05.01.2017
Drawer	RP	File	P5843-70 Jack.dwg



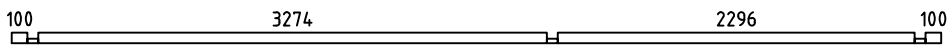
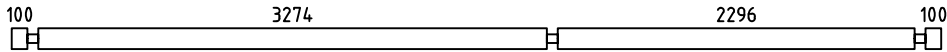
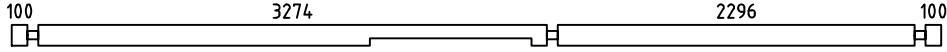
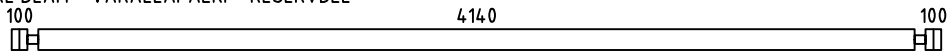
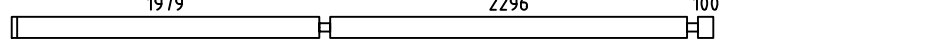
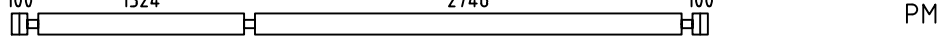
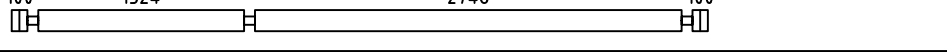
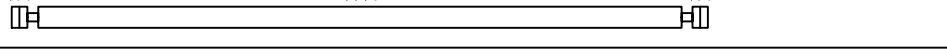
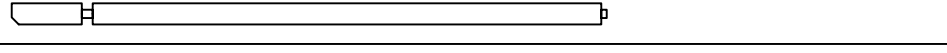
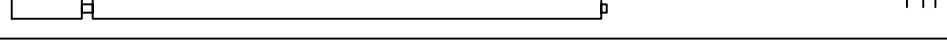
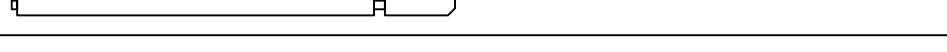
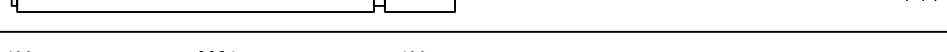
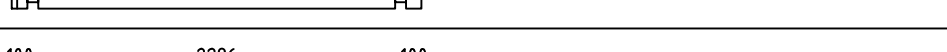
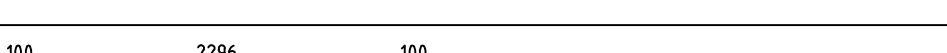
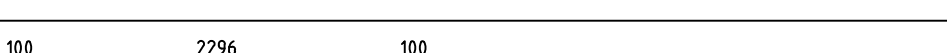
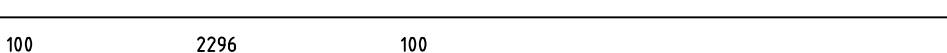
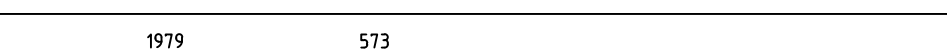
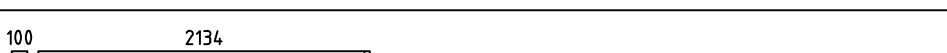





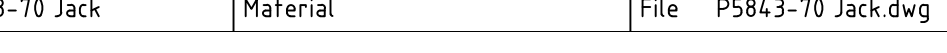

House	P5843-70 Jack	Sheet	13
Drawing	WALL-SEINÄ-VÄGG 3	Scale	1:50
Material	70x135	Date	05.01.2017
Drawer	RP	File	P5843-70 Jack.dwg

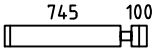
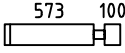
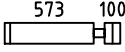



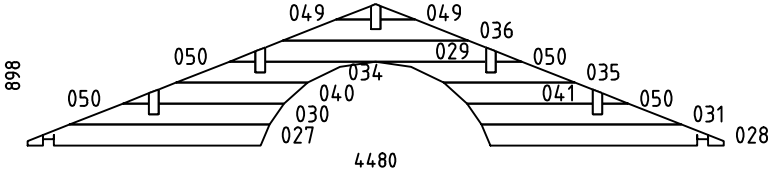
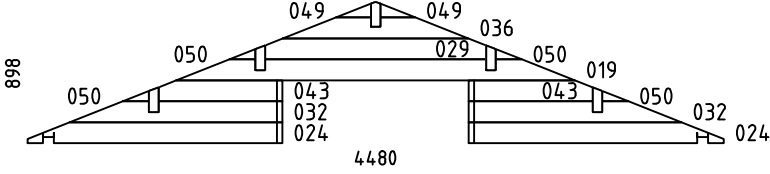
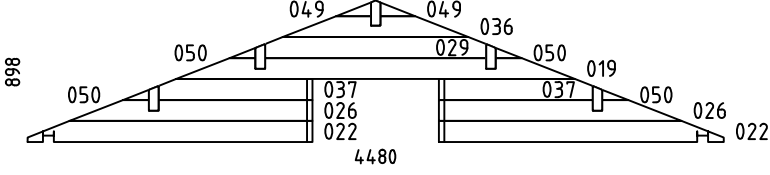

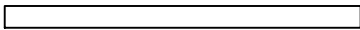
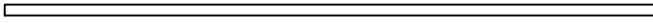
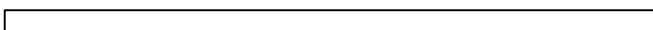
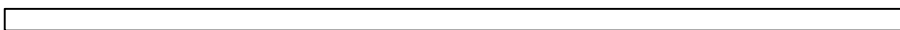
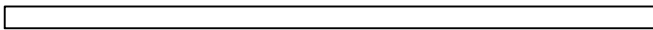
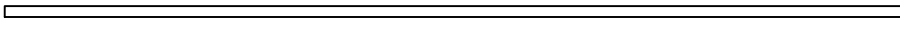
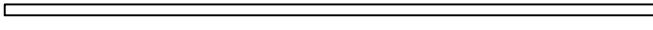





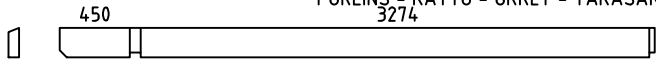
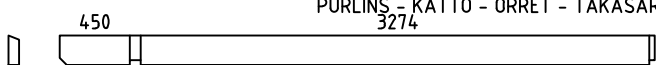
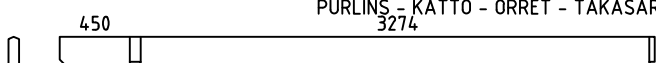
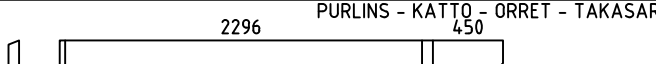
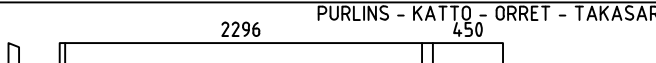
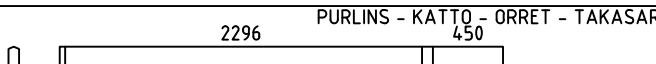





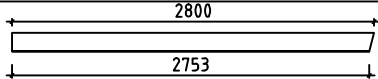



















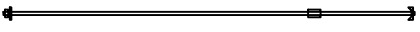

House	P5843-70 Jack	Sheet	14
Drawing	CORNER DECORATION - HÖRN DEKORATION	Scale	1:50
Material		Date	05.01.2017
Drawer	RP	File	P5843-70 Jack.dwg

001		1	70x68	5980	
002		6	70x135	5980	
003		1	70x135	5980	
004	SPARE BEAM - VARALLAPALKI - RESERVDEL 	1	70x135	5980	
005		9	70x135	4515	
006		PM	1	70x135	4480
007		18	70x135	4480	
008		6	70x135	4480	
009		2	70x135	3829	
010		PM	2	70x135	3829
011		2	70x135	2851	
012		PM	2	70x135	2851
013		10	70x135	2636	
014		1	70x68	2636	
015		1	70x68	2636	
016		16	70x135	2636	
017		1	70x68	2636	
018		5	70x135	2622	
020		10	70x135	2304	
021		1	70x68	2304	
023		4	70x135	1833	
025		6	70x135	1640	
033		15	70x135	1367	
038		5	70x135	973	
039		5	70x135	973	
House P5843-70 Jack		Material	File P5843-70 Jack.dwg	Sheet 15	





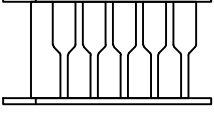
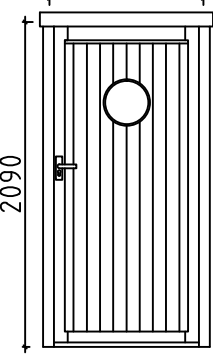
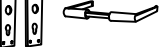

042		30	70x135	915
044		10	70x135	743
045		15	70x135	743
046		14	70x135	415
047		5	70x135	411
048		15	70x135	270
WA-1		1	70x898	4480
WB-1		1	70x898	4480
WC-1		1	70x898	4480
HB	HIT BLOCK-ASENNUSPALKI-SLAG BRÄDA 	2	70x135	300
LB1	LOFT FLOOR BEAMS-PARVIAPALKIT-LOFTBJÄLKAR 	11	43x140	2290
FB4	FLOORBEAMS - LATTIAPALKIT - GOLVBJÄLKAR 	1	140x70	4184
FB3	FLOORBEAMS - LATTIAPALKIT - GOLVBJÄLKAR 	2	70x140	4184
FB5	FLOORBEAMS - LATTIAPALKIT - GOLVBJÄLKAR 	2	43x140	5770
FB1	FLOORBEAMS - LATTIAPALKIT - GOLVBJÄLKAR 	12	43x140	4184
FB6	FLOORBEAMS - LATTIAPALKIT - GOLVBJÄLKAR 	2	43x70	5770
FB2	FLOORBEAMS - LATTIAPALKIT - GOLVBJÄLKAR 	12	43x70	4184
FS2	SLEEPING FLOOR SUPPORTING SLAT-PARVIALATTIA TUKILISTA -LOFTGOLVLIST 	2	43x43	2740
FS1	SLEEPING FLOOR SUPPORTING SLAT-PARVIALATTIA TUKILISTA -LOFTGOLVLIST 	2	43x43	1320
House P5843-70 Jack		Material	File P5843-70 Jack.dwg	Sheet 16

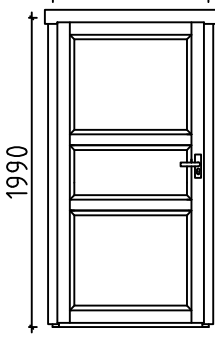
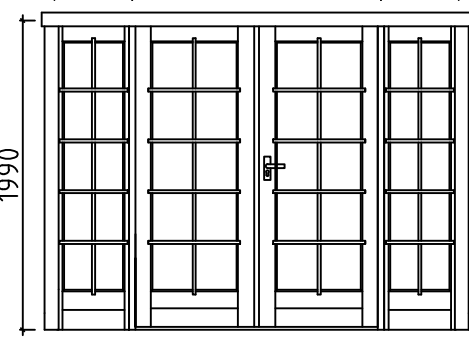
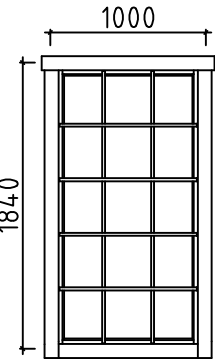
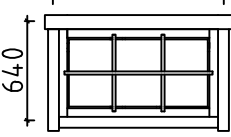
Pos	P5843-70 Jack			Pcs. St.	Profil(e) (mm)	L (mm)
BB1	COUNTERFLOOR HOLDING BOARDS-ROSSIPOHJAA KANNATTELEVAT LAUDAT-BRÄDER SOM HALLER TROSSBOTTEN			2	120x19	4270
BB2	COUNTERFLOOR HOLDING BOARDS-ROSSIPOHJAA KANNATTELEVAT LAUDAT-BRÄDER SOM HALLER TROSSBOTTEN			10	90x19	4270
RB5	PURLINS - KATTO - ORRET - TAKASAR 3274			2	68x190	3829
RB1	PURLINS - KATTO - ORRET - TAKASAR 3274			2	68x190	3829
RB3	PURLINS - KATTO - ORRET - TAKASAR 3274			1	68x190	3829
RB6	PURLINS - KATTO - ORRET - TAKASAR 450			2	68x190	2851
RB2	PURLINS - KATTO - ORRET - TAKASAR 450			2	68x190	2851
RB4	PURLINS - KATTO - ORRET - TAKASAR 450			1	68x190	2851
F1	FLOORBOARD - LATTIALAUTA - GOLVBRÄDE		114 or-tai-eller 88	37+1 48+1	114x28 88x28	3270
F2	FLOORBOARD - LATTIALAUTA - GOLVBRÄDE		114 or-tai-eller 88	37+1 48+1	114x28 88x28	2290
L1	LOFT BOARD - PARVIALATTIA - LOFTGOLV		114 or-tai-eller 88	21+1 28+1	114x19 88x19	4135
R1	ROOFBOARD - KATTOLAUTA - TAKBRÄDE		114 or-tai-eller 88	118+2 154+2	114x19 88x19	2750
FF1	SKIRTING SLAT - LATTIALISTA - GOLVLIST				19x35	47 m
GB1	GABLE BOARD - KAAPELILAUTA - GAVELBRÄDA			4	19x120	2800
GS1	BOARD MATCHING WITH GABLE BOARD-KAAPELILAUTA VASTAVA LAUTA-BRÄDA OVANPÅ GAVELBRÄDA			4	19x70	2800
EB1	EAVE BOARD - RÄYSTÄSLAUTA - TAKFOTBRÄDE			4	19x90	3340
ES1	EAVE SLAT - RÄYSTÄSLISTA - TAKFOTLIST			4	30x40	3340
DB1	DECORATIVE - KORISTE - PRYDNADS			2	19x90	200
CDB1	CORNER DECORATION BOARD- HÖRN DEKORATION BRÄDE			22	120x19	2790
CDB2	CORNER DECORATION BOARD- HÖRN DEKORATION BRÄDE			3	90x19	2790
CDB3	CORNER DECORATION BOARD- HÖRN DEKORATION BRÄDE			16	70x19	2790
WF1	SIDEWALL SKIRTING SLAT-KATTOLISTA-PÄÄDYT -TAKLIST-GAVLAR			2	19x90	3270
WF2	SIDEWALL SKIRTING SLAT-KATTOLISTA-PÄÄDYT -TAKLIST-GAVLAR			2	19x90	2292
WF3	SIDEWALL SKIRTING SLAT-KATTOLISTA-PÄÄDYT -TAKLIST-GAVLAR			4	19x90	448
CB1	COVERING BOARD-PEITELAUTA-HYLLBRÄDA			1	19x120	2900
SB1	SUPPORT BOARD-TUKILAUTA-KONSOL			2	19x79	155
House	P5843-70 Jack		Material	File	P5843-70 Jack.dwg	
				Sheet	17	

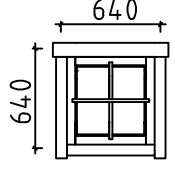
Pos	P5843-70 Jack		Pcs. St.	Profil(e) (mm)	L (mm)	
DT1	DOOR ASSEMBLING PROFILE-OVEN ASENNUSPROFIILI -DÖRR MONTERINGSPROFIL		2	43x70	2060	
DT2	DOOR ASSEMBLING PROFILE-OVEN ASENNUSPROFIILI -DÖRR MONTERINGSPROFIL		6	43x70	1990	
WT1	WINDOW ASSEMBLING PROFILE-IKKUNA ASENNUSPROFIILI -FÖNSTER MONTERINGSPROFIL		2	43x70	1860	
WT2	WINDOW ASSEMBLING PROFILE-IKKUNA ASENNUSPROFIILI -FÖNSTER MONTERINGSPROFIL		8	43x70	640	
FLT1	ASSEMBLING PROFILE-ASENNUSPROFIILI-MONTERINGSPROFIL		2	25x19	780	
SJ1	SCREW JOINT-KIERRETANKO-GÄNGSTAPP		6	ØM10	2770	
RCM	ROOFBEAMS CONNECTING METAL-METALL FÖR SAMMANFOGNING AV TAKASAR-KATTO-ORRE YHTEENLITYSMETALLT		5	Ø6	200	
WCM	WALLBEAMS CONNECTING METAL-METALLPLATTA FÖR SAMMANFOGNING AV VÄGGEN BALKAR-SEINÄPALKKEJA METALLISET YHTEENLIITYMISLAATAT		4	50	50	
	NAILS-NAULAT-SPIKAR FOR-VARTEN-FÖR	FF1		110	Ø2.0	40
	NAILS-NAULAT-SPIKAR FOR-VARTEN-FÖR	F1, F2, L1, R1, BB1, BB2		1600	Ø2.5	60
	SCREWS-RUUVIT-SKRUVAR FOR-VARTEN-FÖR	WCM, CDB3		100	Ø3.5	35
	SCREWS-RUUVIT-SKRUVAR FOR-VARTEN-FÖR	GB1, GS1, EB1, ES1, DB1, CB CDB1, CDB2, WF1, WF2, WF3		300	Ø4.5	50
	SCREWS-RUUVIT-SKRUVAR FOR-VARTEN-FÖR	FS1, FS2, LB1, SB		50	Ø4.5	70
	SCREWS-RUUVIT-SKRUVAR FOR-VARTEN-FÖR	001, 014, 015, 017, 021 FB1, FB2, FB3, FB4, FB5, FB6		80	Ø4.5	90
	SCREWS-RUUVIT-SKRUVAR FOR-VARTEN-FÖR	FB2, FB4, FB6		60	Ø5.0	120
	SCREWS-RUUVIT-SKRUVAR FOR-VARTEN-FÖR	RB1, RB2, RB3, RB4, RB5, RB6		20	Ø6.0	160
LD1	LADDER-TIKAPUUT-STEGE		1	700	2760	
D1	DOOR-OVI-DÖRR (right-oikea-höger) ORT_ST		P	1	990	2090
			1			
			1			

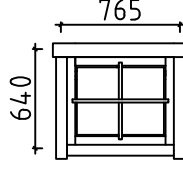
Pos	P5843-70 Jack	Pcs. St.	Profil(e) (mm)	L (mm)
D2	DOOR-OVI-DÖRR (left-jäljellä-vänster) AST 1000 	V 2 2 2	1000	1990
D3	DOOR-OVI-DÖRR (right-oikea-höger) ORT_ST	P 1	1600	1990
W1	WINDOW-IKKUNAN-FÖNSTER ORT_ST_K 500 1600 500 	2 1 1 1 2 2	500	1990
W2	WINDOW-IKKUNAN-FÖNSTER ORT_ST_K 1000 	1 1	1000	1840
W3	WINDOW-IKKUNAN-FÖNSTER ORT_ST_SU 1100 	2 2 2 2	1100	640
House P5843-70 Jack		Material	File P5843-70 Jack.dwg	Sheet 19

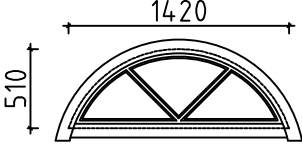
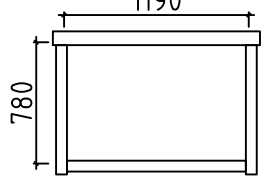
Pos	P5843-70 Jack	Pcs. St.	Profil(e) (mm)	L (mm)
W4	WINDOW-IKKUNAN-FÖNSTER (right-oikea-höger) ORT_ST 	1	640	640
		1		
	+	1		
		1		
W5	WINDOW-IKKUNAN-FÖNSTER ORT_ST_SU 	1	765	640
		1		
	+	1		
		1		
W6	WINDOW-IKKUNAN-FÖNSTER ORT_ST_K 	1	1420	510
FL1	FRAME AROUND LOFT ENTRANCE 	1	1190	780

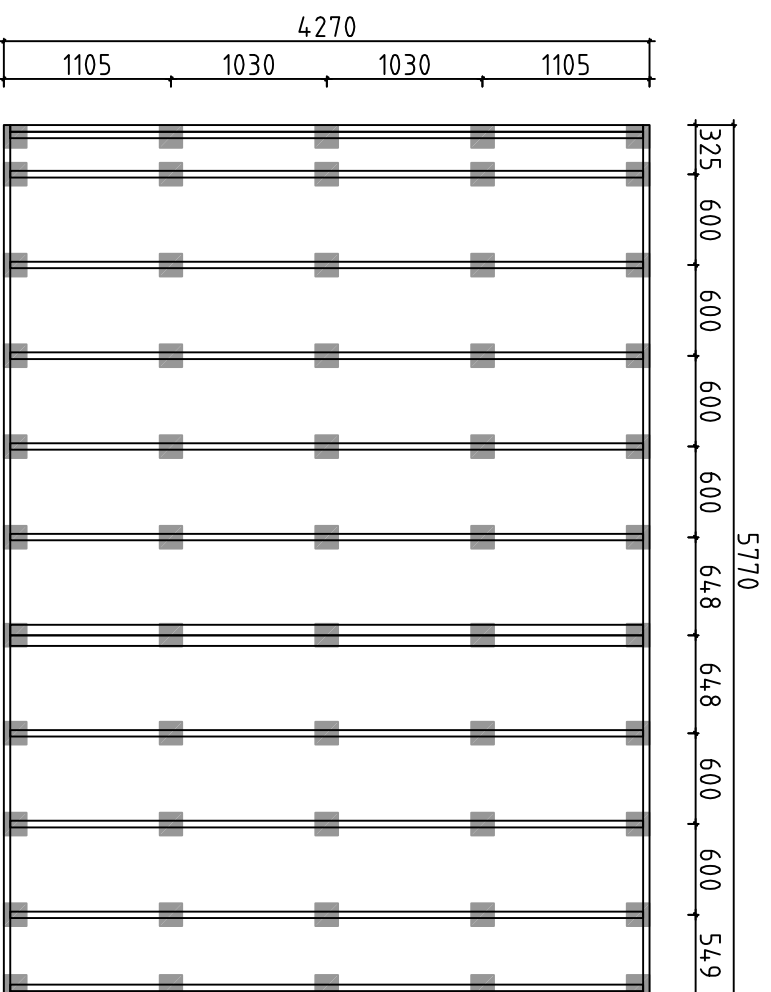

Detta är ett förslag för hur man kan placera plintarna (100-200 mm i diameter) för golvbjälklaget. Golvbjälkarna är med i byggsatsen, men inte plintarna. Använder man exempelvis 500-600mm långa murblock så kan man halvera antalet punkter. Lägg fuktskyddande papp mellan betong och trä

Tämä on ehdotus siltä, miten (100-200 mm läpimitäiset) jalat voidaan sijoittaa alapohjaa varten. Lattiapalkit ovat rakennussarjassa, mutta jalat ei ole. Kun käytetään esimerkiksi 500-600 mm pitkiä harkkoja, voidaan pisteiden määrä puolitaa. Aseta betonin ja puun väliin kosteudelta suojaava pähvi

A proposal for placing plinths (100-200 mm in diameter) for floor beams. Floor beams are provided in the kit but plinths are not included. For example, by using 500-600 mm long masonry units, one can reduce the number of points 50%. Place cardboard between the concrete and wood to protect from moisture

House	P5843-70 Jack	Sheet	21
Drawing	FOUNDATION PLAN - PLINTPLAN	Scale	1:50
Material		Date	05.01.2017
Drawer	RP	File	P5843-70 Jack Foundation.dwg

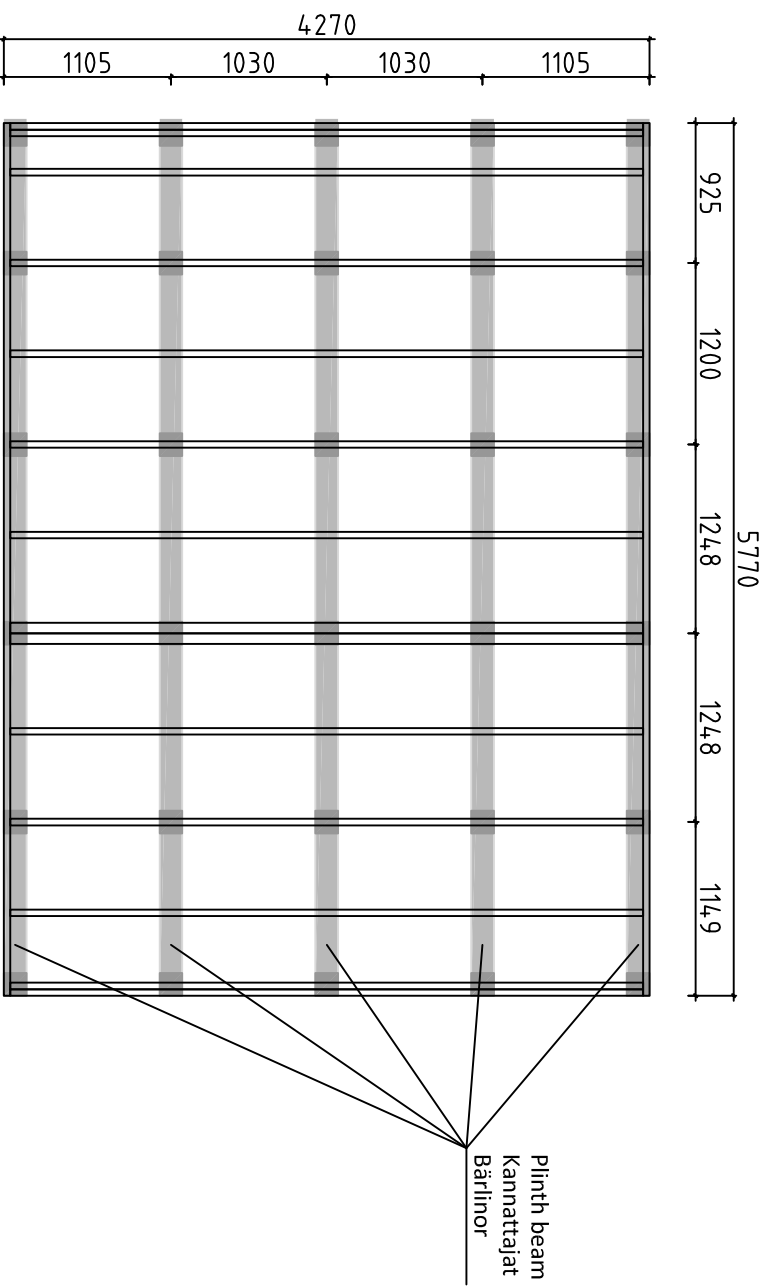

Förslag på alternativ plintplan med bärlnor och plintar. Bärlnor 45x95 eller 45x120 och plintar ca 100-200 mm i diameter. (Bärlnor och plintar ingår ej i leveransen). Används exempelvis murblock, (ingår ej i leveransen) istället för plintar, kan man lägga bärlnorra platt mot dessa och på det sättet minska höjden på konstruktionen. I denna konstruktion kan man dessutom lägga en "boardskiva" mellan bärlnorra och golvbjälkarna och på det sättet bära upp bjälklagsisoleringen. Lagg fuktskyddande papp mellan betong och trä

Endotus valtoehtoisestä jalustasta kannattajilla ja jalolla. Kannattajat 45x95 tai 45x120 ja jalat läpimitataan n. 100-200 mm (kannattajat ja jalat ei ole toimituksessa). Käytettäessä esimerkiksi harkkoja (ei kuulu toimitukseen) jalkojen sijasta, voi kannattajat asettaa lappeelleen niitä vasten ja sillä tavoin vähentää rakenteen korkeutta. Tässä rakenteessa voi lisäksi asettaa levyä kannattajien ja lattiapalkkien väliin ja sillä tavoin kannattaa alapohjan eristystä. Aseta betonin ja puun väliin kosteudelta suojaava pahvi

A proposal for alternative plinth beam layout plan. Plinth beams 45x95 or 45x120 and plinths ca 100-200 mm in diameter (plinth beams and plinths are not included in the kit). For example, by using masonry units (not included in the kit) instead of plinths, one can lay plinth beams flat against the masonry units and in that way reduce the height of the structure. In this construction one can also add "plywood board" between plinth beams. Place cardboard between the concrete and wood to protect from moisture

House	P5843-70 Jack	Sheet	22
Drawing	FOUNDATION PLAN - PLINTPLAN	Scale	1:50
Material		Date	05.01.2017
Drawer	RP	File	P5843-70 Jack Foundation.dwg

#001	3	5980	1
#002	1,3	5980	6
#003	1	5980	1
#004		5980	1
#005	3	4515	9
#006	B	4480	1
#007	B,C	4480	18
#008	A,C	4480	6
#009	1,3	3829	2
#010	1,3	3829	2
#011	1,3	2851	2
#012	1,3	2851	2
#013	1	2636	10
#014	1	2636	1
#015	2	2636	1
#016	2	2636	16
#017	2	2636	1
#018	3	2622	5
#019	B,C	2565	2
#020	1	2304	10
#021	1	2304	1
#022	C	1833	2
#023	C	1833	4
#024	B	1640	2
#025	B	1640	6
#026	C	1562	2
#027	A	1558	1
#028	A	1558	1
#029	A,B,C	1424	3
#030	A	1380	1
#031	A	1380	1
#032	B	1369	2
#033	B	1367	15
#034	A	1283	1
#035	A	1283	1
#036	A,B,C	1194	3
#037	C	991	2
#038	1	973	5
#039	1	973	5
#040	A	960	1
#041	A	960	1
#042	A	915	30
#043	B	798	2
#044	1,3	743	10
#045	B	743	15
#046	3	415	14
#047	1	411	5
#048	B	270	15
#049	A,B,C	224	6
#050	A,B,C	168	12