

Portsmouth 44
Art. Nr.4420102
1/12

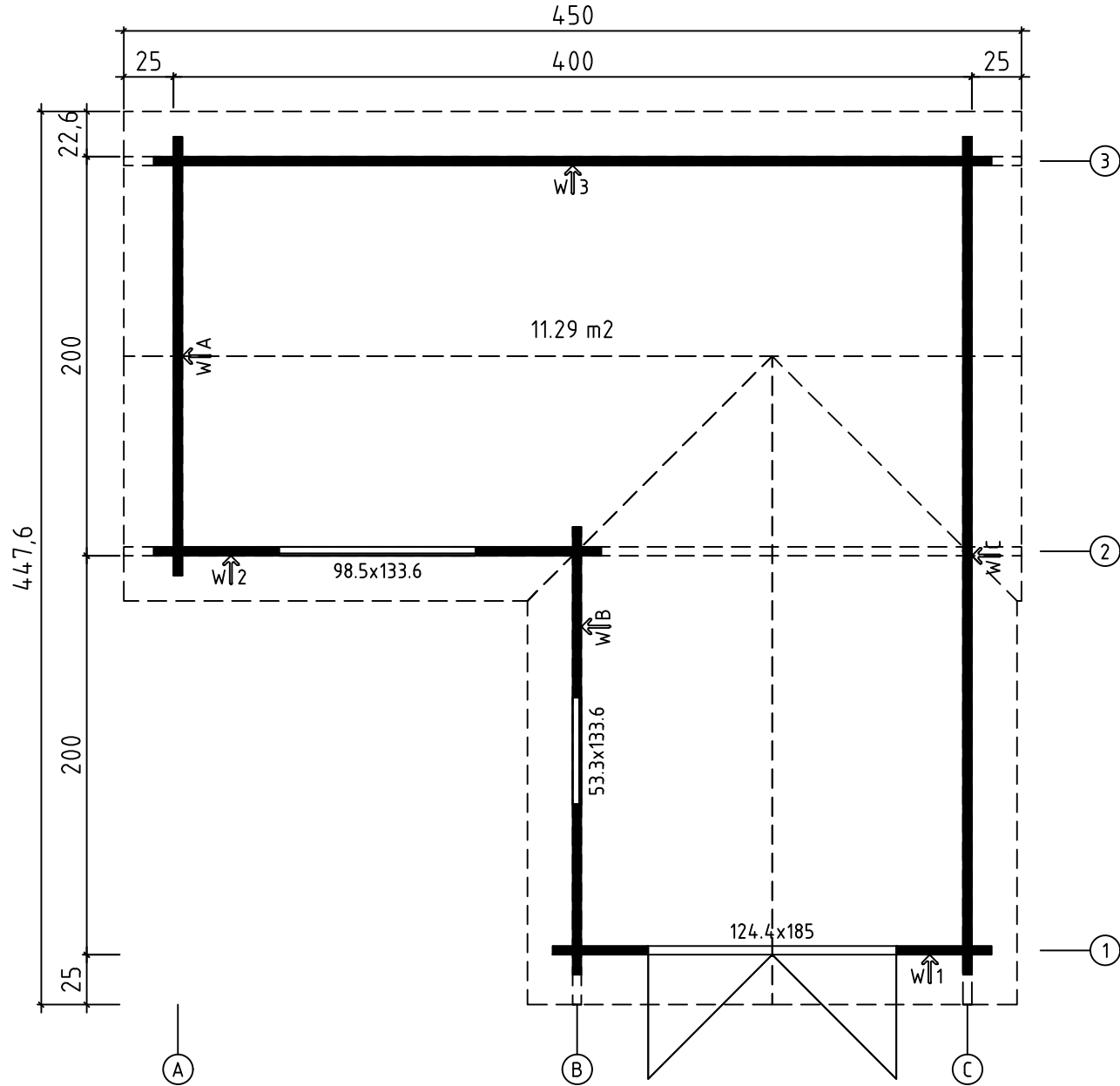

24.01.2017

GROUNDPLAN - GRUNDPLAN - PLAN DE MASSE



FOUNDATION - FUNDAMENT - FONDATION

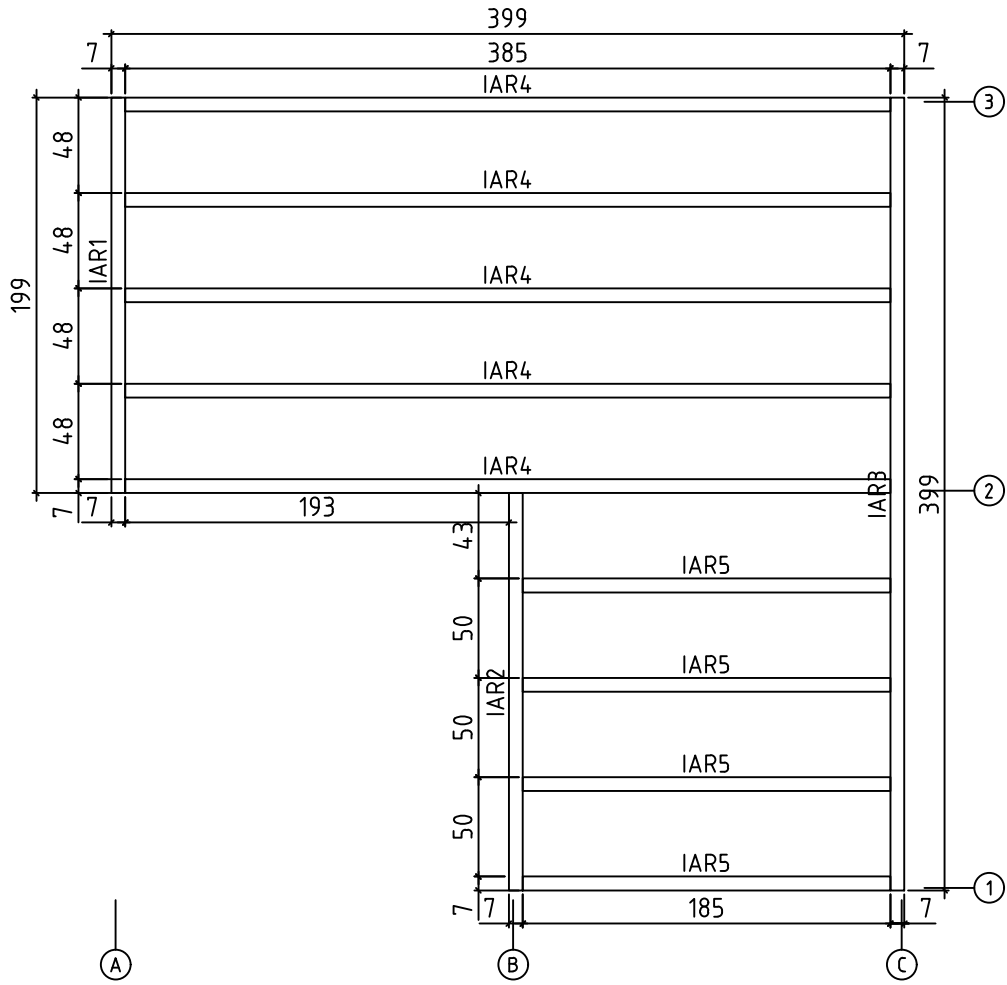

FLOOR BOARDS - FUSSBODENBRETTER - PLAN POSE PLANCHER

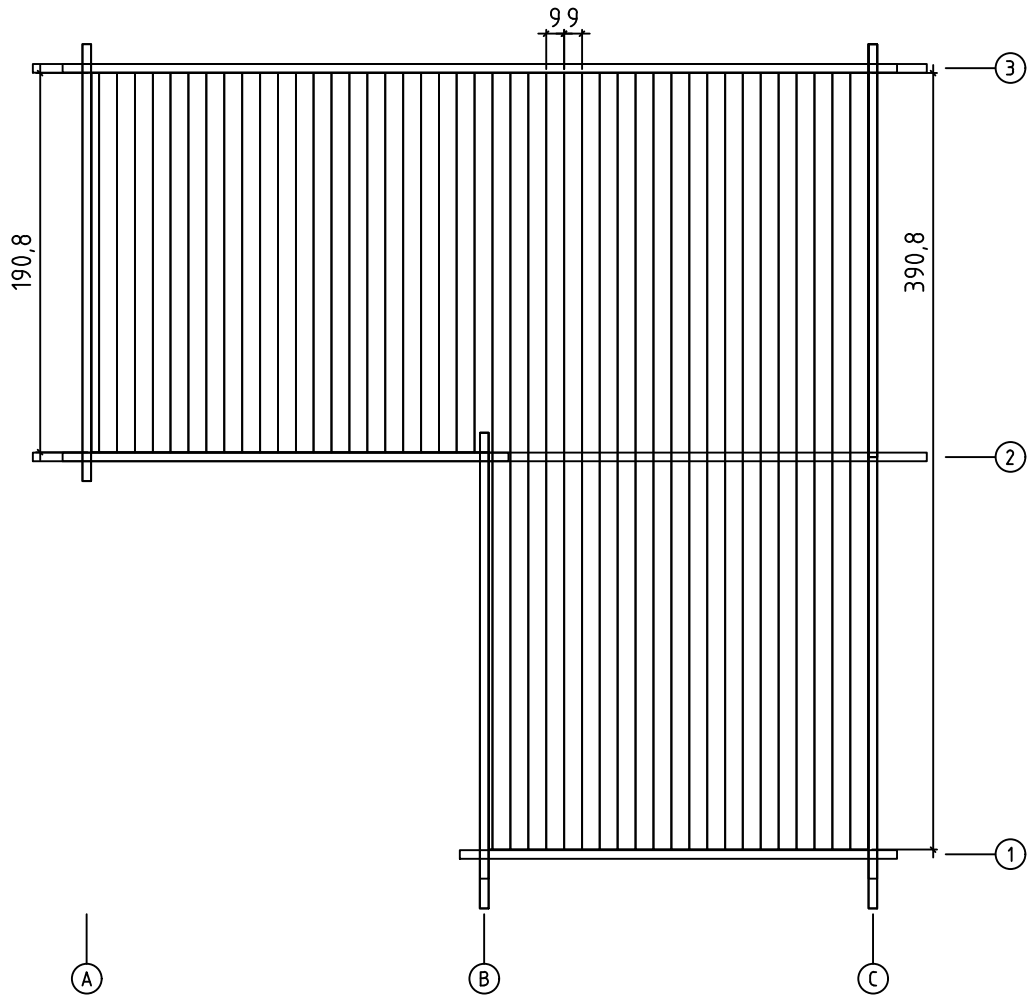

ROOF BEAM - DACHPFETTEN - PANNE DE TOIT

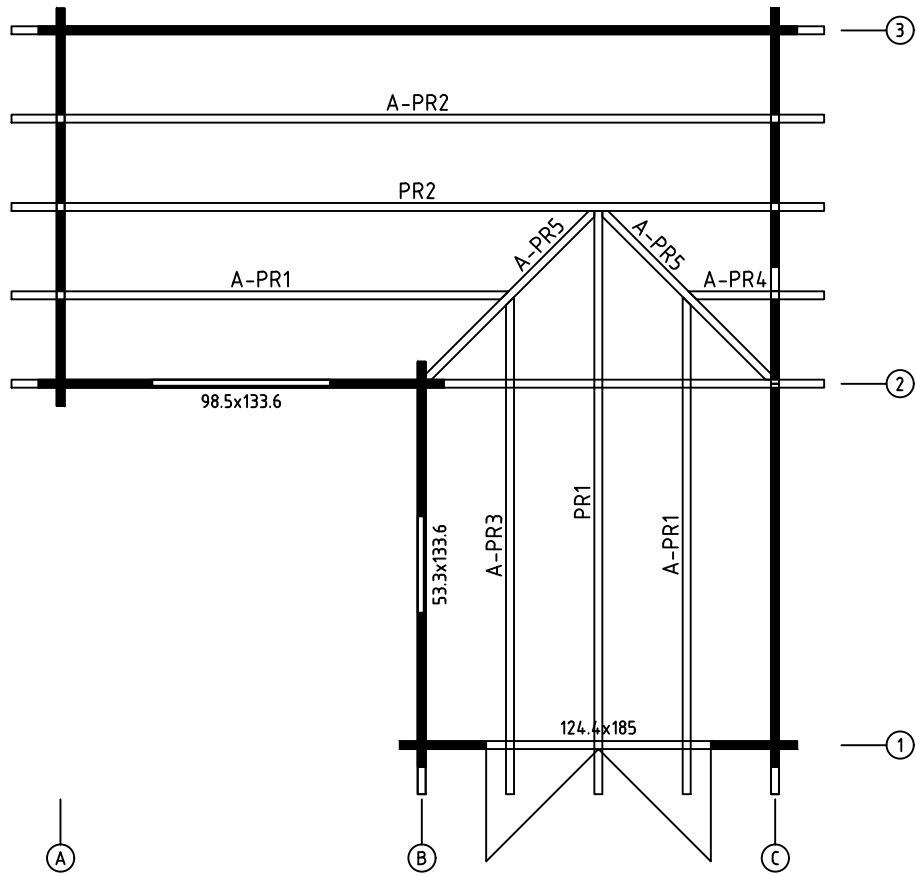

ROOF PLAN - DACH-PLAN - PLAN DU TOIT

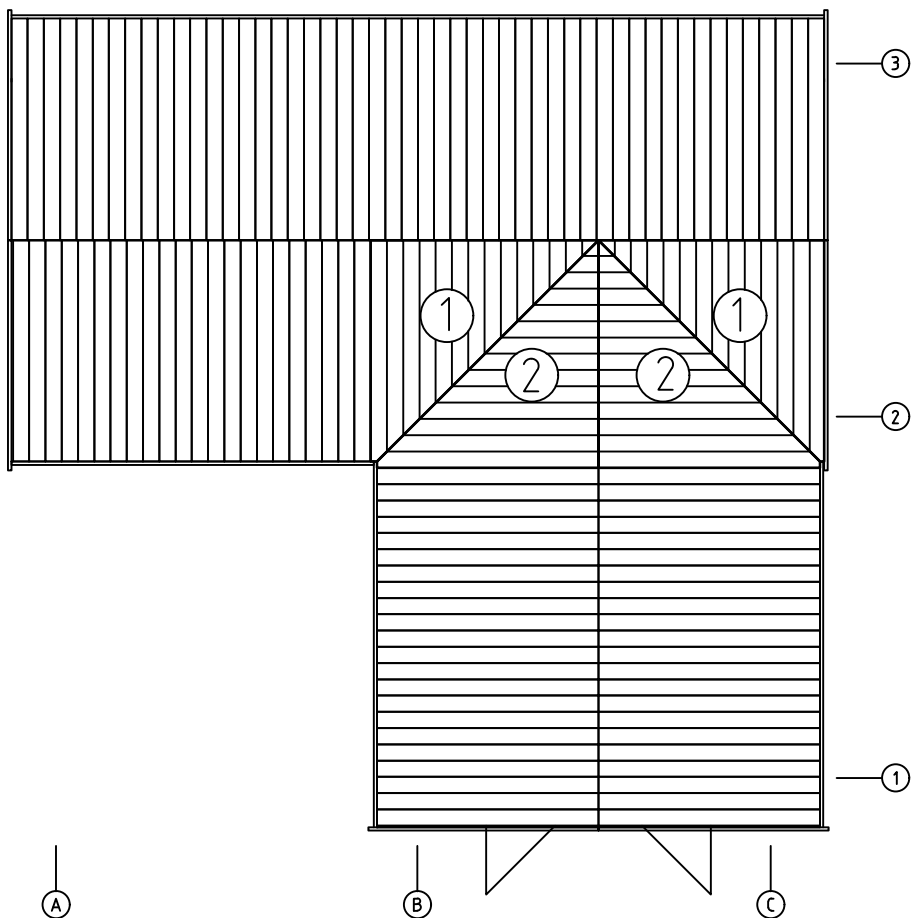

NB! Numbered roofboards are longer than necessary, please install them first and cut excess part of roofboards!

NB! Les voliges numérotées sont plus longues que nécessaires, merci de les installer au première et puis couper la partie excédentaire de la volige

NB! Achtung: Die nummerierten Dachbretter sind länger als nötig. Installieren Sie diese bitte zuerst und schneiden dann den überschüssigen Teil ab.

Art.Nr. 4420102

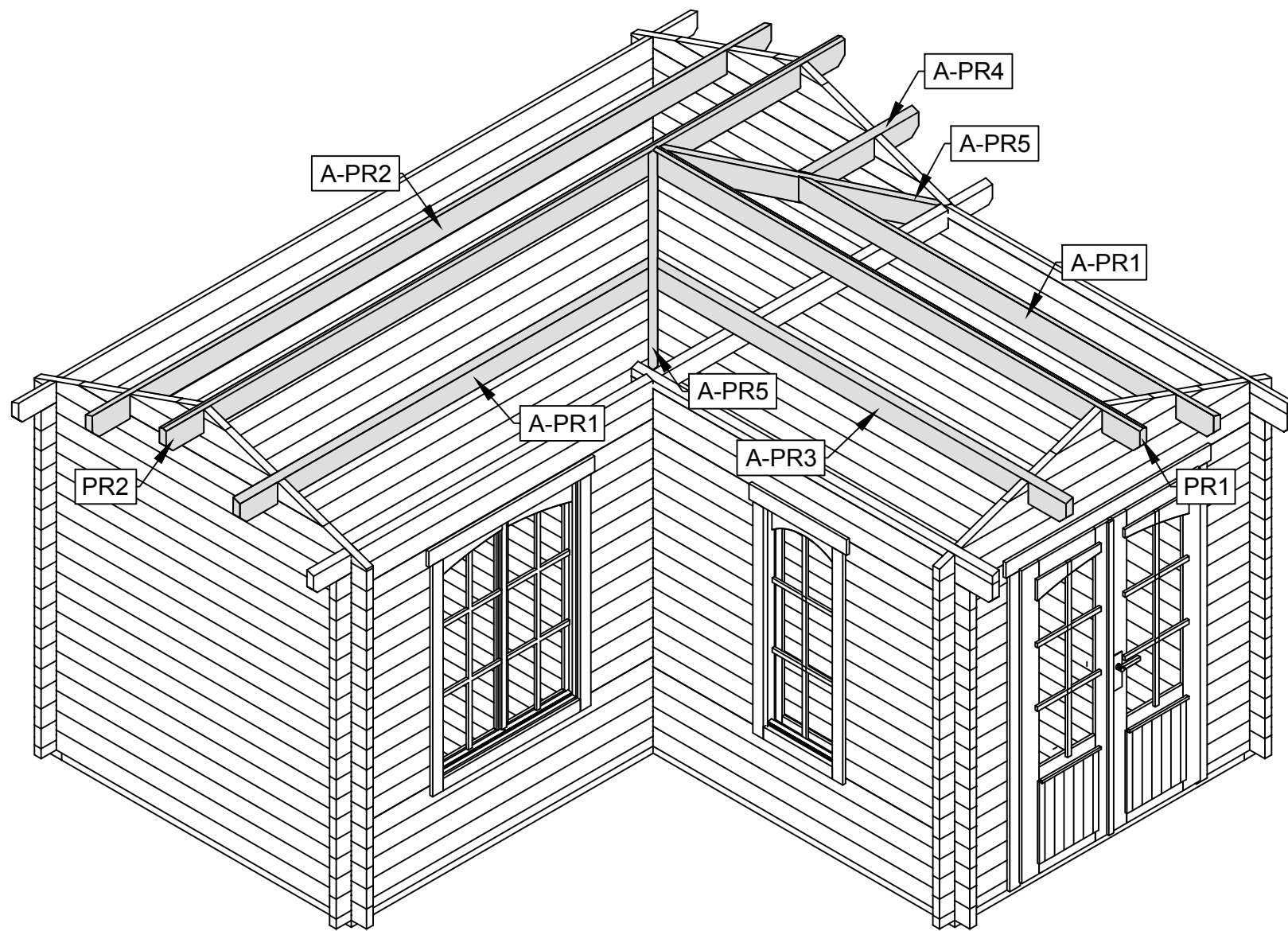



24.01.2017

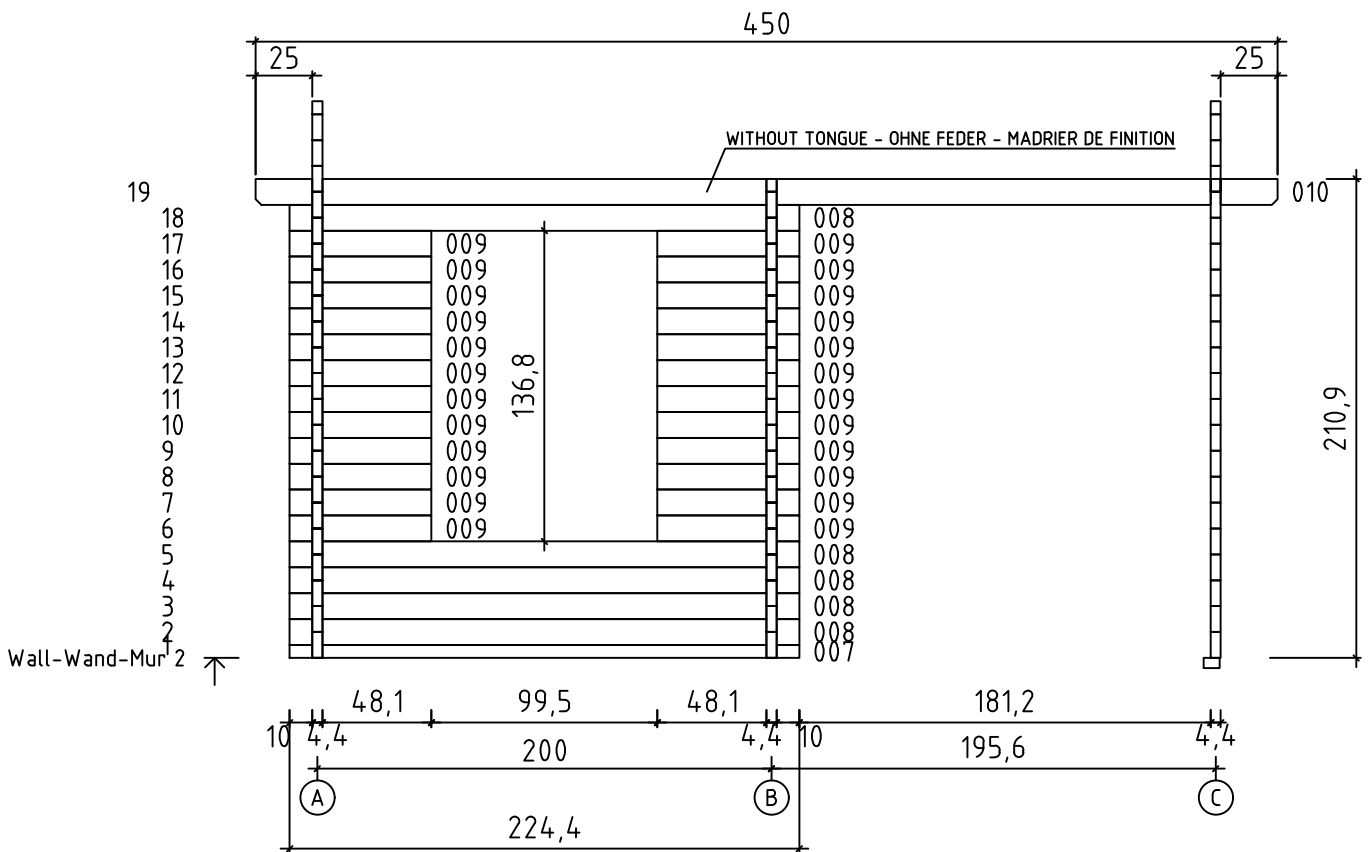
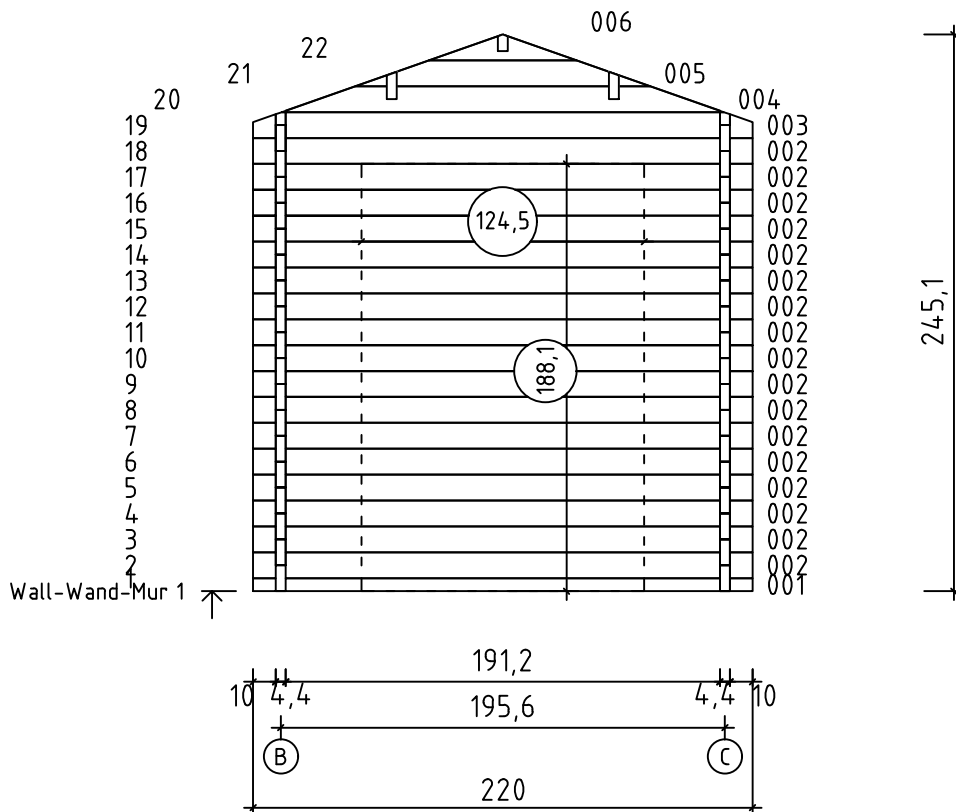

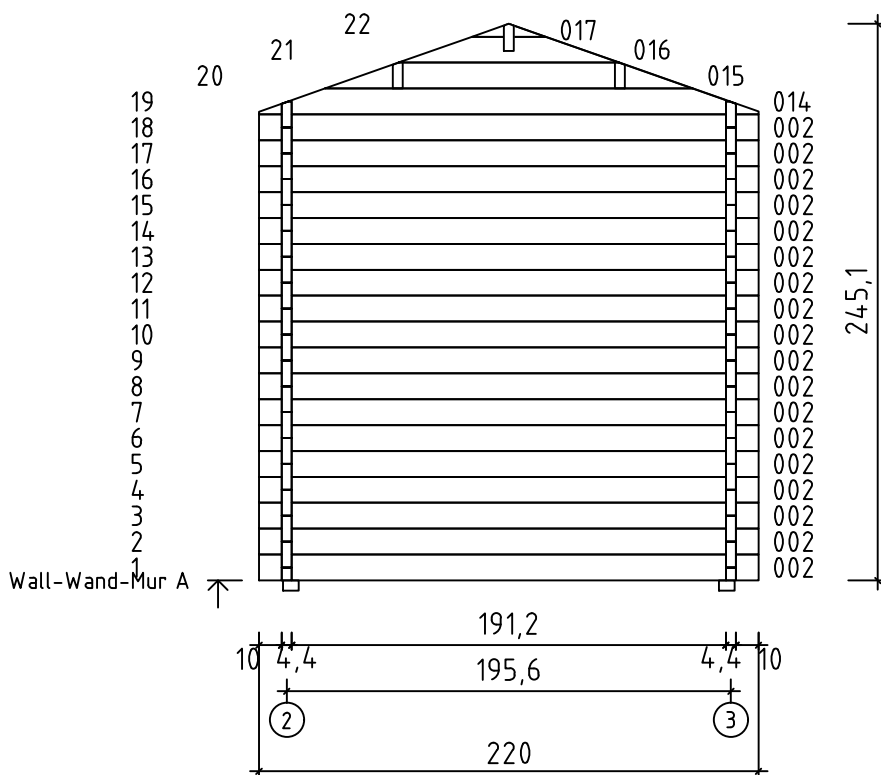
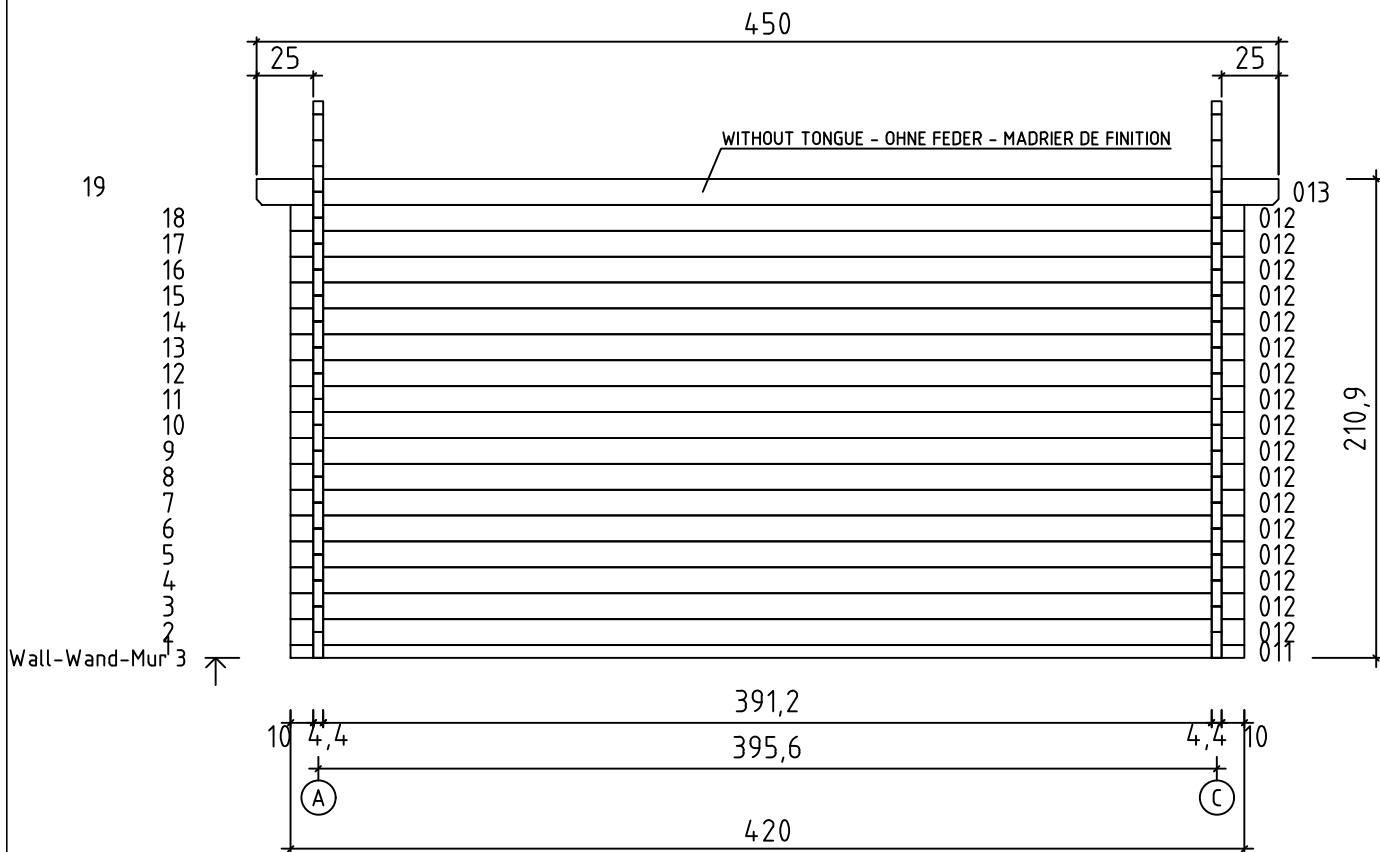

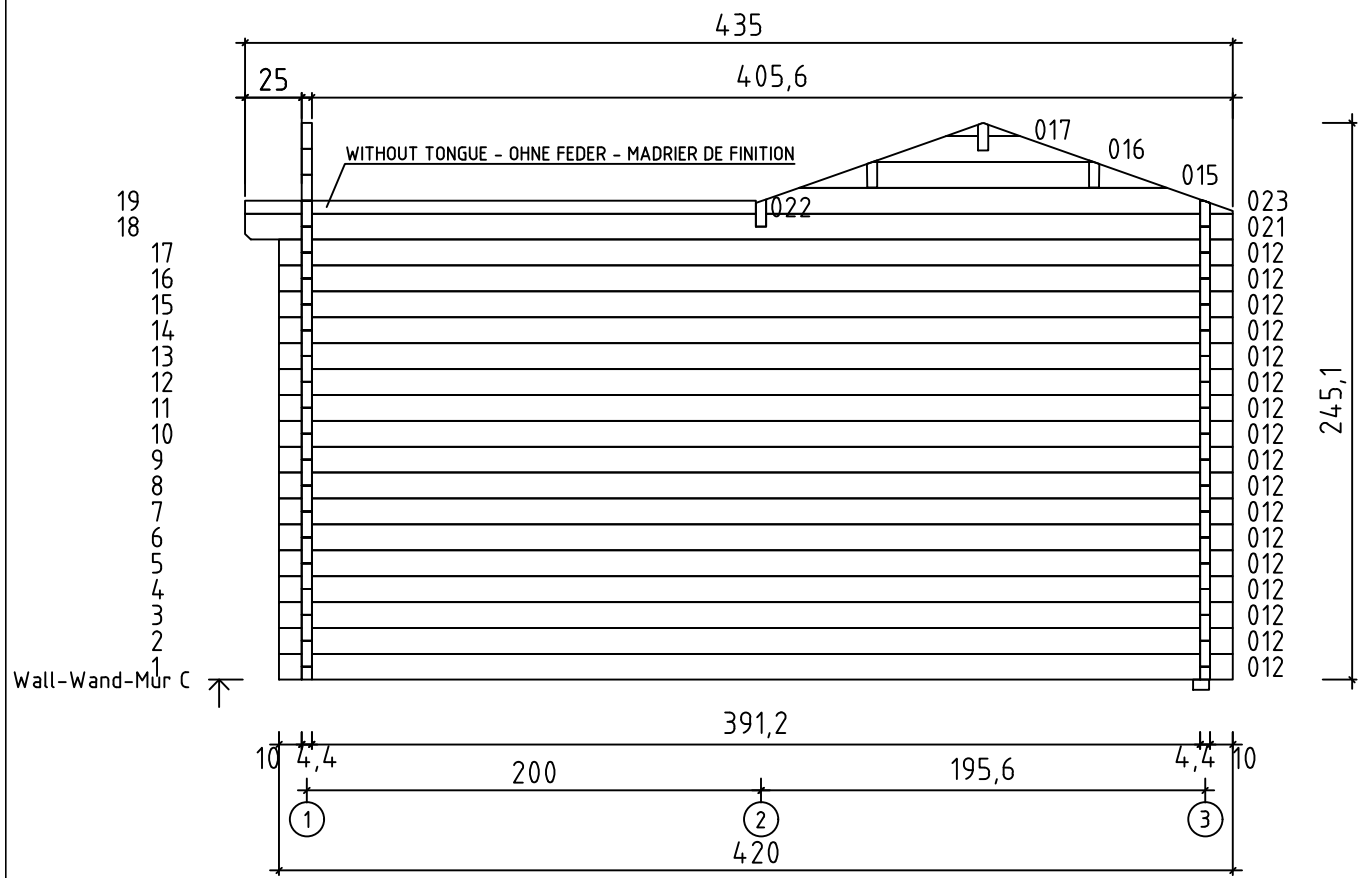
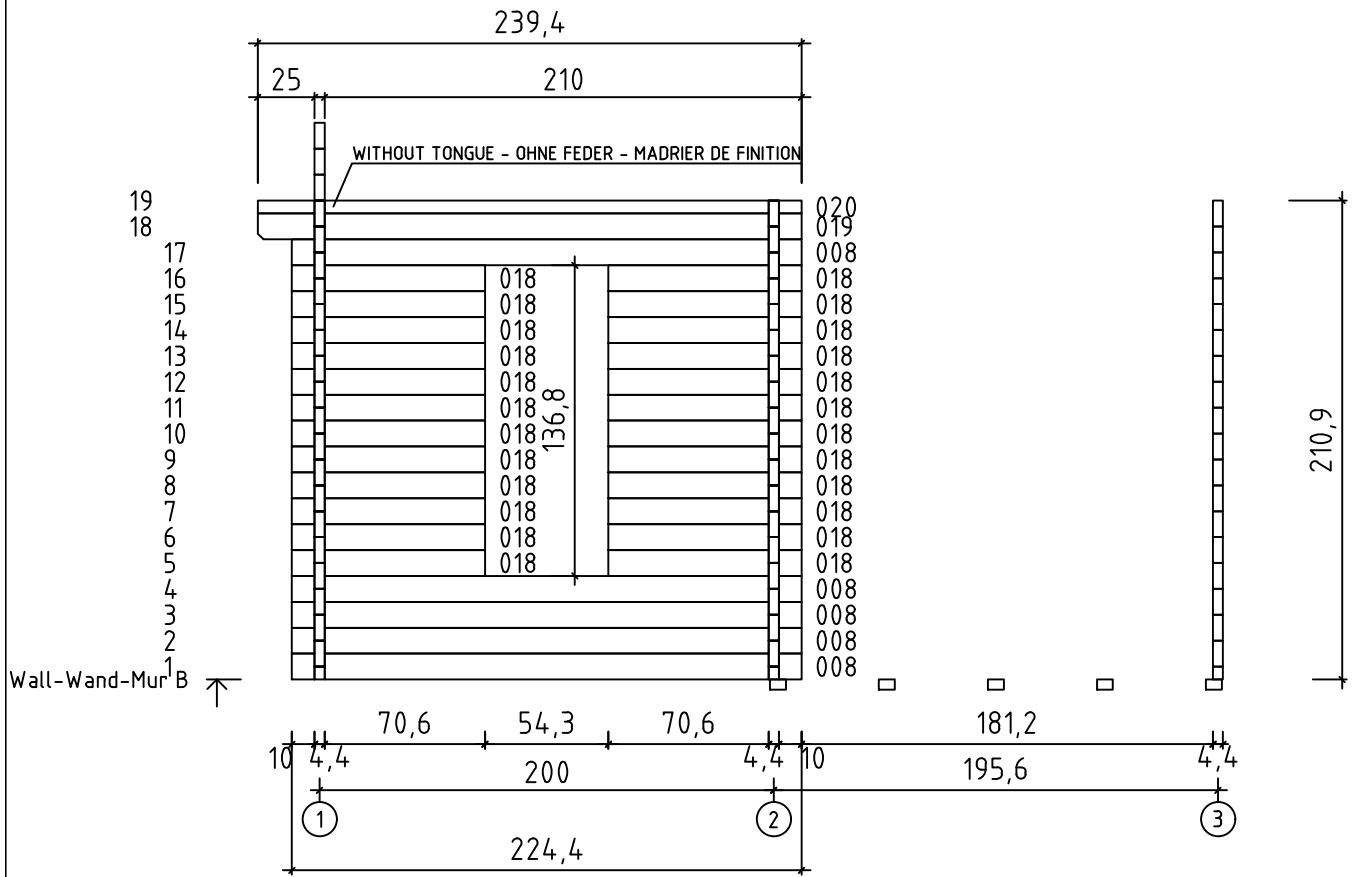

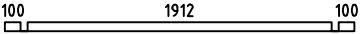
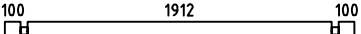
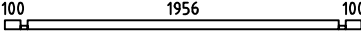
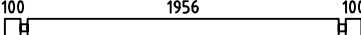
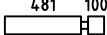
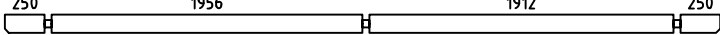
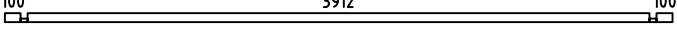
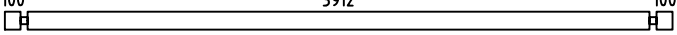
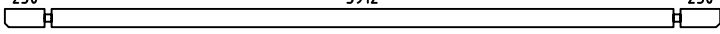
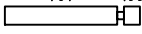
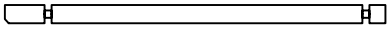
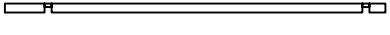
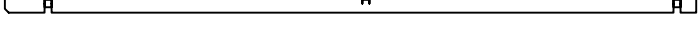
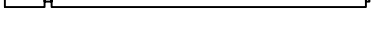
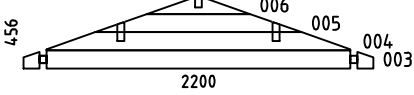
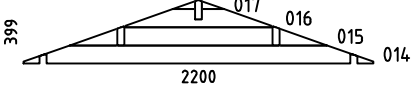
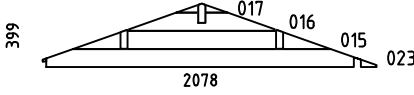
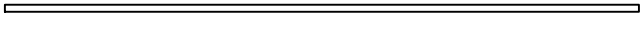

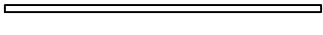
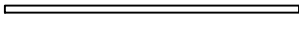
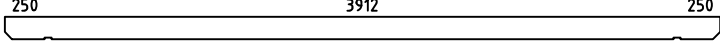
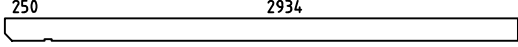

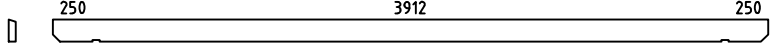
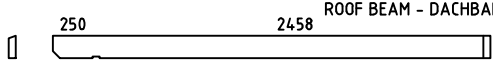
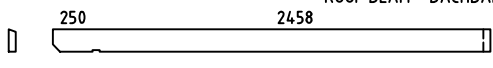
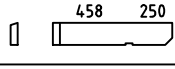
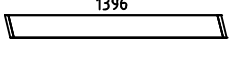



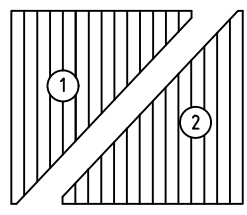

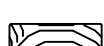
5/12

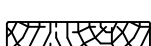

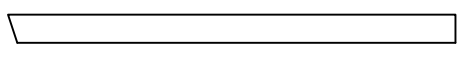
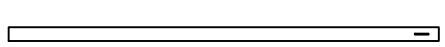







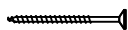
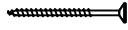
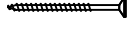
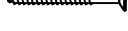

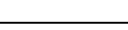
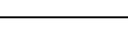
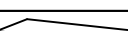



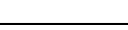
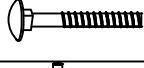

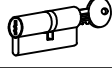

Pos	24.01.2017	Piece list - Stückliste - Liste des pièces Art.Nr. 4420102	9/12	Q	P (mm)	L (mm)
001				1	44x57	2200
002				35	44x114	2200
007				1	44x57	2244
008				10	44x114	2244
009				24	44x114	625
010				1	44x120	4500
011				1	44x57	4200
012				34	44x114	4200
013				1	44x120	4500
018				24	44x114	851
019				1	44x114	2394
020				1	44x63	2394
021				1	44x114	4350
022				1	44x63	2272
W1-1				1		
WA-1				1		
WC-1				1		
IAR3				1	70x45	3990
IAR4				5	70x45	3850
IAR2				1	70x45	2000
IAR1				1	70x45	1990
IAR5				4	70x45	1850
PR2				1	44x140	4500
PR1				1	44x140	3228

Pos	24.01.2017	Piece list - Stückliste - Liste des pièces Art.Nr. 4420102	10/12	Q	P (mm)	L (mm)
A-PR2		ROOF BEAM - DACHBALKEN - PANNE DE TOIT 3912		1	44x140	4500
A-PR1		ROOF BEAM - DACHBALKEN - PANNE DE TOIT 2458		2	44x140	2752
A-PR3		ROOF BEAM - DACHBALKEN - PANNE DE TOIT 2458		1	44x140	2752
A-PR4		ROOF BEAM - DACHBALKEN - PANNE DE TOIT		1	44x140	752
A-PR5		ROOF BEAM - DACHBALKEN - PANNE DE TOIT		2	44x140	1396
	FLOOR BOARDS - FUSSBODENBRETTER - LAME DE PLANCHER			22	90x18	3908
	FLOOR BOARDS - FUSSBODENBRETTER - LAME DE PLANCHER			22	90x18	1908
	ROOF BOARDS - DACHBRETTER - VOLIGES			120	90x18	1300
	ROOF BOARDS - DACHBRETTER - VOLIGES			2 2		
	FLOOR FILLET - FUSSBODENLEISTE - CORNIERE DE FINITION DU PLANCHER				18x18	15.63
	ROOFING FELT FILLET - DACHPAPPENLEISTE - BAGUETTE DE FIXATION DU FEUTRE BITUMEUX			1	18x58	1350
	ROOFING FELT FILLET - DACHPAPPENLEISTE - BAGUETTE DE FIXATION DU FEUTRE BITUMEUX			4	18x58	1350
TB-3	FASCIA BOARD - TRAUFBRETT - BANDEAU DE TOIT			3	18x90	2050
TB-4	FASCIA BOARD - TRAUFBRETT - BANDEAU DE TOIT			2	18x90	2250
DRV-3	ROOF EDGE REINFORCEMENT - DACHRANDVERSTÄRKUNG - CORNIERE DE RENFORT DE BORD DE TOIT			3	28x34	2050
DRV-4	ROOF EDGE REINFORCEMENT - DACHRANDVERSTÄRKUNG - CORNIERE DE RENFORT DE BORD DE TOIT			2	28x34	2250
	GABLE MOULDING - GIEBELLEISTE - PLANCHE DE RIVE			6	18x120	1350
KFS-1	STORM PROTECTION - STURMLEISTE - LATTE ANTI-TEMPETE			6	22x45	2050
FS	WINDOW HANDLE FITTINGS - FENSTERGRIFF - POIGNEE DE FENETRE			2		
HS1	SCREW FOR GEORGIAN BARS - SCHRAUBE FÜR SPROSSEN - VIS DE BARRES GEORGIENNE			30	2.5x20	
HS1	SCREW FOR GEORGIAN BARS - SCHRAUBE FÜR SPROSSEN - VIS DE BARRES GEORGIENNE			18	2.5x20	
HS8	SCREW FOR GABLE SEGMENT - SCHRAUBEN FÜR DECKBLATT - VIS POUR FIXATION LOSANGE DE FINITION			6	3.5x35	
HS9	SCREW FOR GABLE MOULDING - SCHRAUBEN FÜR GIEBELLEISTE - VIS POUR FIXATION PLANCHE DE RIVE			36	3.5x50	

Pos	24.01.2017	Piece list - Stückliste - Liste des pièces Art.Nr. 4420102	11/12	Q	P (mm)	L (mm)
HS4		SCREW FOR DOOR FILLET - SCHRAUBE ZUR BEFESTIGUNG TÜRLEISTE - VIS POUR FIXATION BAGUETTE D'ARRET DE PORTE		5	3x30	
HS12		SCREW FOR FASCIA BOARDS - SCHRAUBEN FÜR TRAUFBRETT - VIS POUR FIXATION BANDEAU DE TOIT		25	4x40	
HS12		SCREW FOR ROOF EDGE REINFORCEMENT - SCHRAUBEN FÜR DACHRANDVERSTÄRKUNG - VIS POUR FIXATION CORNIERE RENFORT DE BORD DE TOIT		25	4x40	
HS18		SCREW FOR FOUNDATION - SCHRAUBEN ZUR BEFESTIGUNG FUNDAMENT - VIS DE FIXATIONS DES POUTRELLES DE FONDATIONS		19	5x120	
HS18		SCREW FOR ROOF BEAMS - SCHRAUBEN FÜR DACHBALKEN - VIS POUR FIXATION PANNES DE TOIT		37	5x120	
HS16		SCREW FOR 1. WALL BEAM - SCHRAUBE FÜR 1. BOHLENREIHE - VIS DE FIXATIONS 1ere RANGÉE DE MADRIERS AVEC POUTRELLES DE FONDATIONS		8	5x90	
HS16		SCREW FOR DOOR JAMB - SCHRAUBE FÜR TÜRRAHMEN - VIS DE FIXATION PARTIE HAUTE AVEC MONTANTS DU CADRE DE PORTE		4	5x90	
HS25		SCREW FOR DOORSTEP - SCHRAUBEN FÜR SWELLE - VIS POUR FIXATION BARRE DE SEUIL		3	4.5x65	
NF2		ZN NAIL FOR FLOOR FILLET - ZN NÄGEL FÜR FUSSBODENLEISTE - POINTE POUR CORNIERE DE FINITION DU PLANCHER		33	1.4x40	
SH44		HAMMER BLOCK - SCHLAGHOLZ - CALLE DE FRAPPE		1		
SFS		NUT FOR STORM PROTECTION - SCHRAUBENMUTTER FÜR STURMLEISTE - ECROU POUR LATTE ANTI-TEMPETE		12		
NF4		ZN NAIL FOR ROOF - ZN NÄGEL FÜR DACHBRETT - POINTE POUR FIXATION VOLIGES DE TOIT		528	2x50	
NF4		ZN NAIL FOR FLOOR - ZN NÄGEL FÜR FUSSBODENBRETT - CLOUS POUR PLANCHER		207	2x50	
NF5		ZN NAIL FOR ROOFING FELT FILLET - ZN NÄGEL FÜR DACHPAPPENLEISTE - POINTE POUR BAGUETTE DE FIXATION FEUTRE BITUMEUX		24	2x40	
BFS		BOLT FOR STORM PROTECTION - BOLZEN FÜR STURMLEISTE - BOULON POUR LATTE ANTI-TEMPETE		12		
		MALE BOLT HINGE FOR DOOR - TÜRRIEGEL - PARTIE MALE DE PAUMELLE DE PORTE		6		
GS		GABLE SEGMENT - DECKBLATT - LOSANGE DE FINITION		3		
DFS		WASHER FOR STORM PROTECTION - DICHTSCHEIBE FÜR STURMLEISTE - RONDELLE POUR LATTE ANTI-TEMPETE		12		
TL4		DOOR HANDLE FITTINGS - TÜRGRIF - POIGNEE DE PORTE		1		
TL5		SET OF DOOR LOCK COVERS - SCHLOSSBLENDE - SET DE GARNITURES DE PORTE		1		
		CYLINDER LOCK - ZYLINDERSCHLOSS - BARILLET DE PORTE		1	30x35	
HC		COVERS FOR DOOR HINGES - SCHUTZKAPPE FÜR TÜRBAND - COUVERTURE DE PAUMELLE DE PORTE		12		
		STRIKER FOR BARREL BOLT - HÜLSE FÜR GRENDRIEGEL - GACHE AU SOL DU TARGETTE		2		

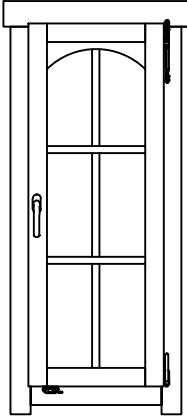
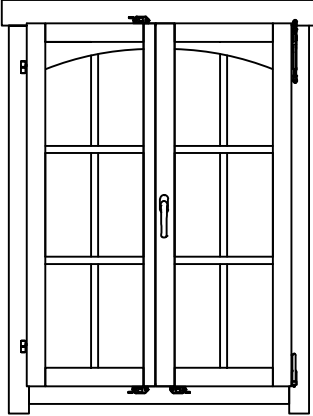
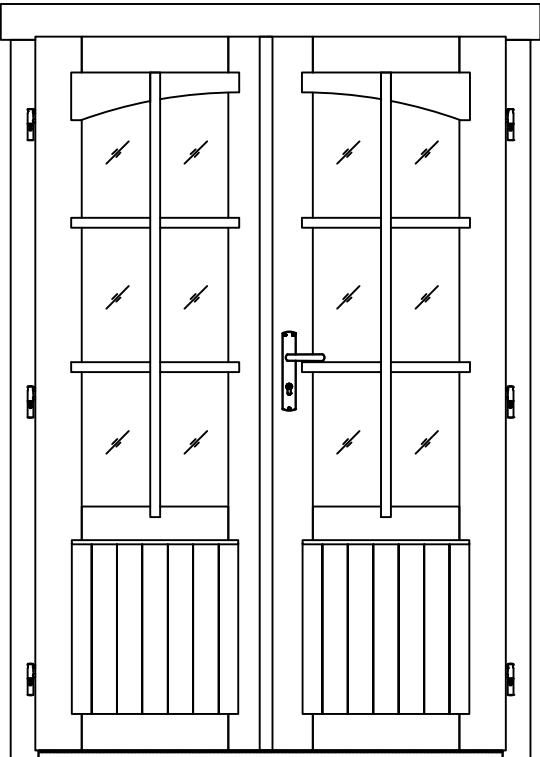
Pos	24.01.2017 Piece list - Stückliste - Liste des pièces Art.Nr. 4420102	12/12	Q	P (mm)	L (mm)
	<p data-bbox="236 152 746 183">WINDOW - FENSTER - FENETRE 533x1336</p> <p data-bbox="874 152 1075 183">AK.1.106.PSP. Kg</p> <p data-bbox="1129 152 1232 183">DGP+A+</p> 	1			
	<p data-bbox="236 694 746 725">WINDOW - FENSTER - FENETRE 985x1336</p> <p data-bbox="874 694 1075 725">TAK.1.106.PSP.Kf</p> <p data-bbox="1129 694 1232 725">DGP+A+</p> 	1			
	<p data-bbox="236 1236 635 1267">DOOR - TÜR - PORTE 1244x1850</p> <p data-bbox="762 1236 1043 1267">TUK.2.066.PVP. MMKWe</p> <p data-bbox="1129 1236 1232 1267">DGP+A+</p> 	1			