

Date rev. Description

House P584.3-90 Edwin

Sheet 1

Drawing 3D

Scale

Material 90x160

Date 04.12.2017

Drawer RP

File P584.3-90 Edwin 3D.dwg

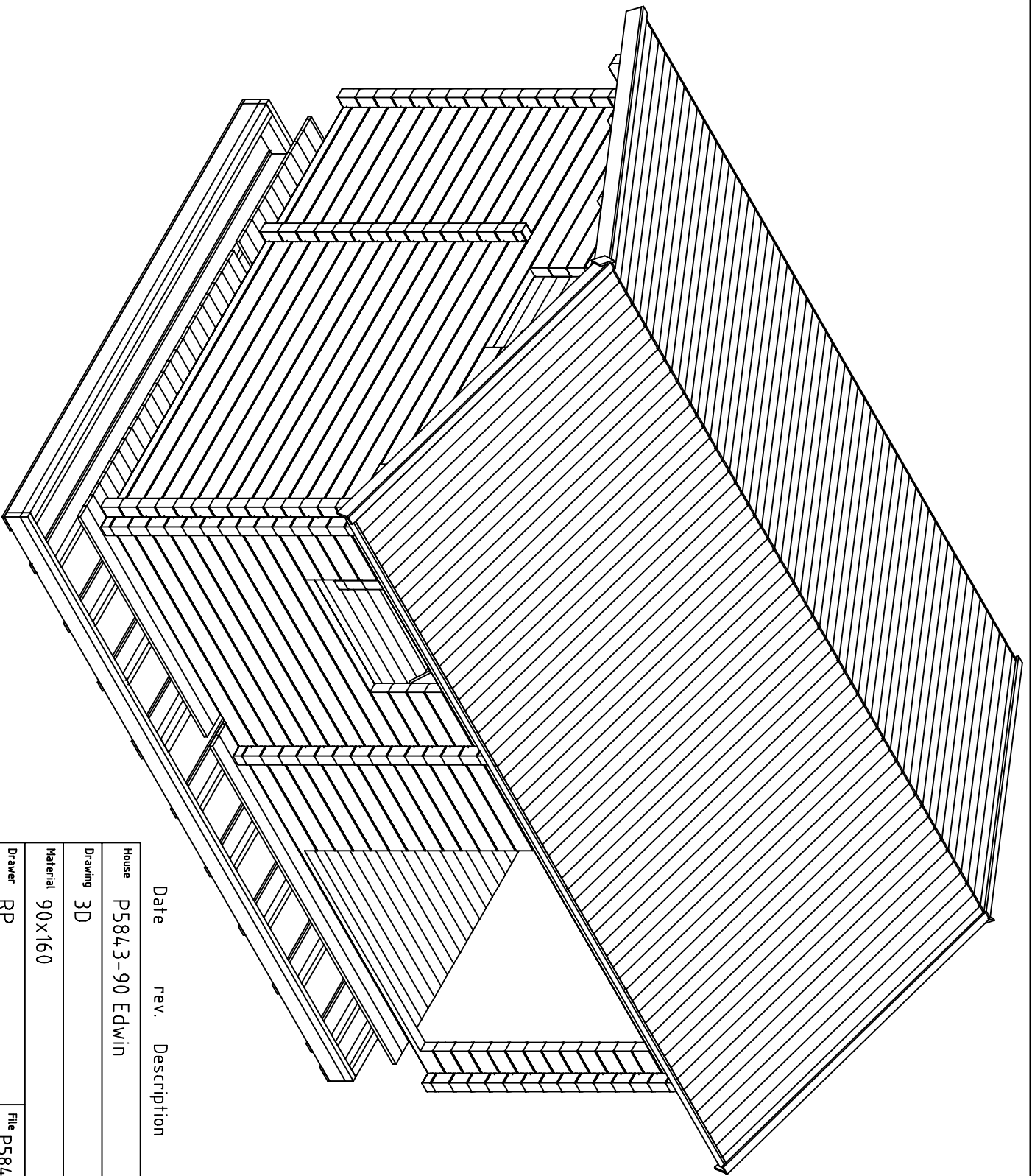

Date rev. Description

House P5843-90 Edwin Sheet 2

Drawing 3D Scale

Material 90x160 Date 04.12.2017

Drawer RP File P5843-90 Edwin 3D.dwg

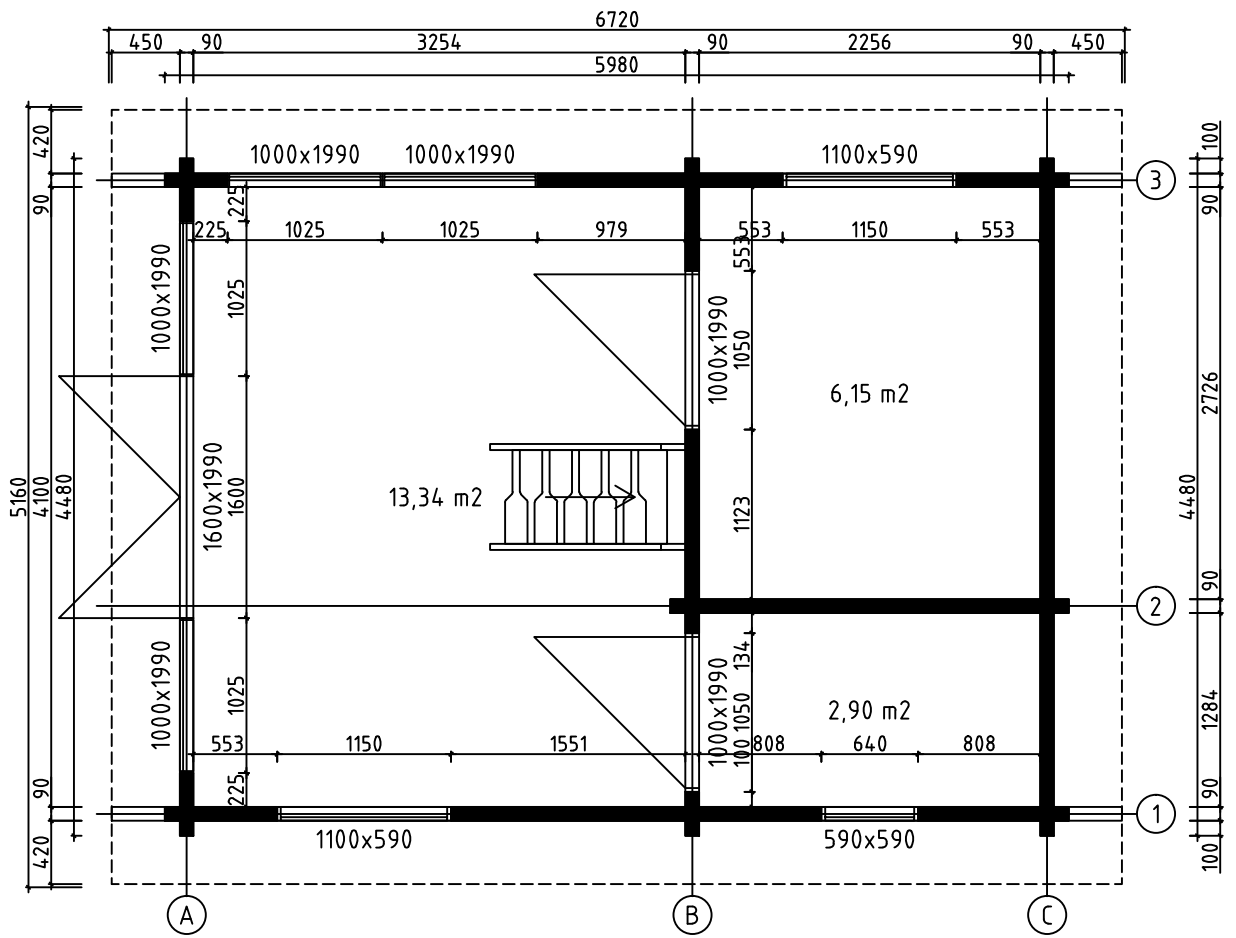

House	P5843-90 Edwin	Sheet	3
Drawing	PLAN-SUUNNITELMA-PLANEN	Scale	1:50
Material	90x160	Date	04.12.2017
Drawer	RP	File	P5843-90 Edwin.dwg

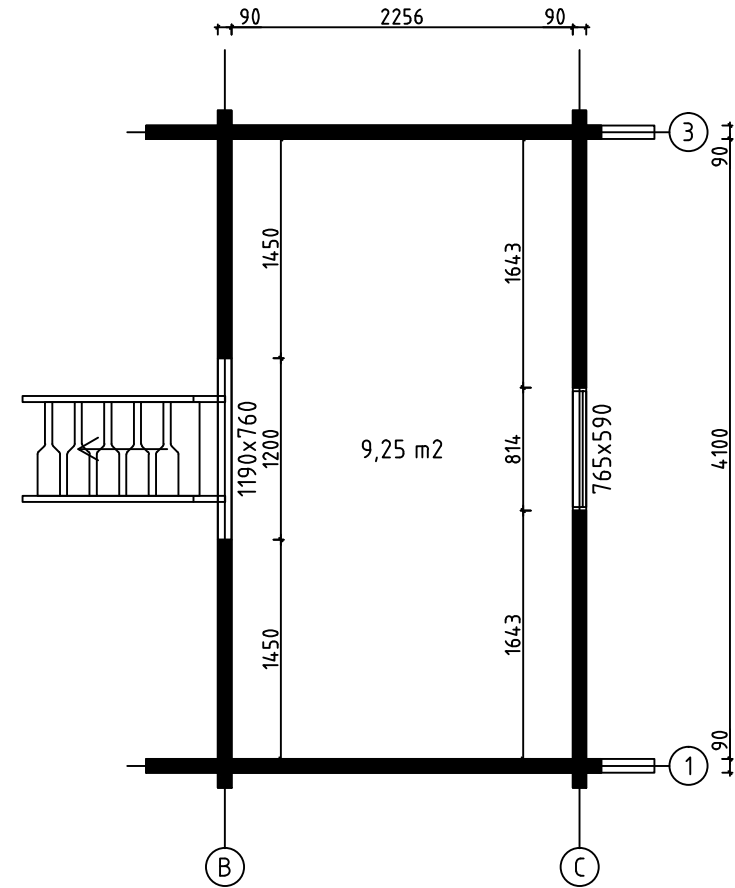
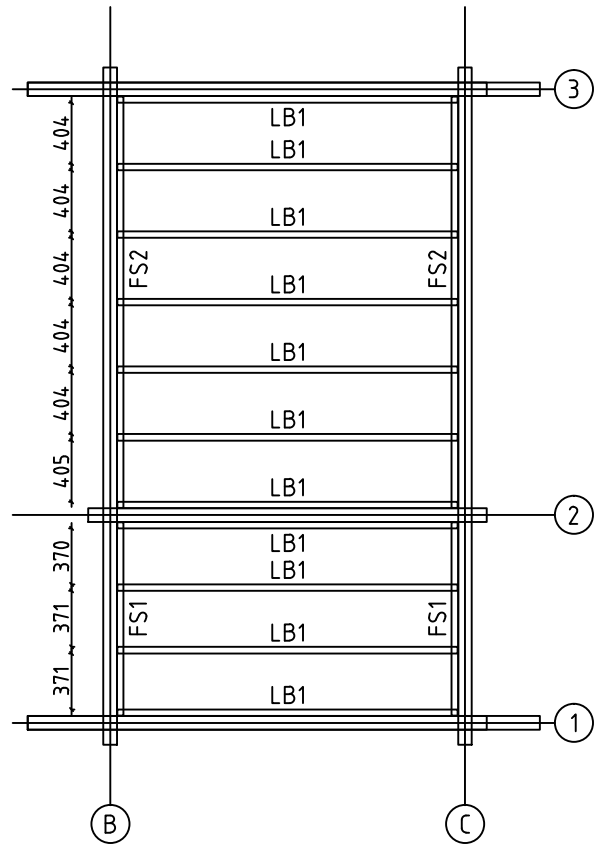

LOFT FLOOR BEAMS - PARVIA LATTIAPALKIT - LOFT GOLVBJÄLKAR

House	P5843-90 Edwin	Sheet	4
Drawing	LOFT FLOOR - PARVIA LATTIA - LOFT GOLV	Scale	1:50
Material	43x43, 43x140 90x160	Date	04.12.2017
Drawer	RP	File	P5843-90 Edwin.dwg

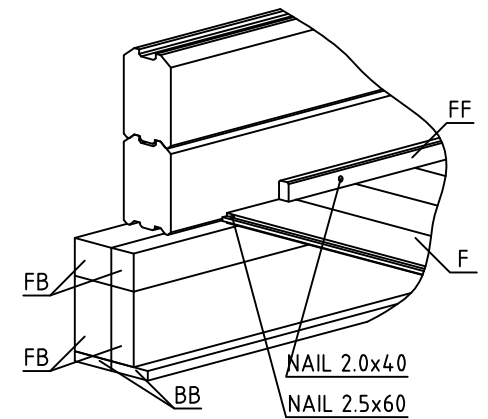
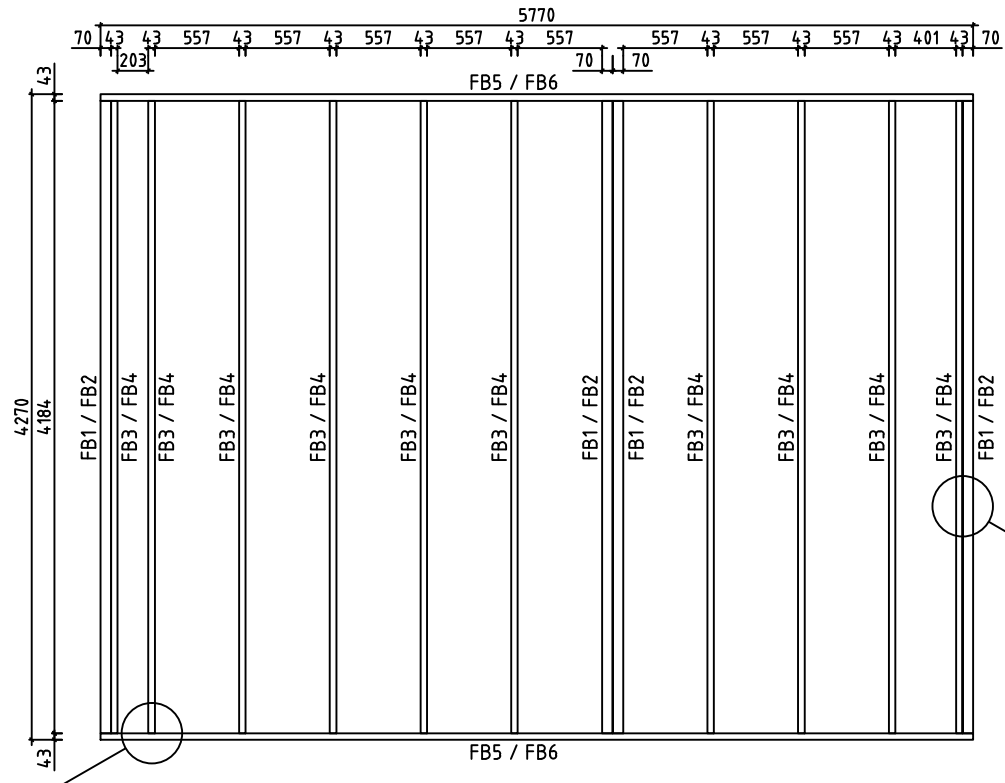
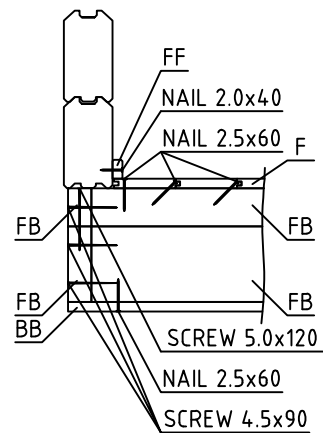

House	P5843-90 Edwin	Sheet	5
Drawing	FLOORBEAMS-LATTIAPALKIT-GOLVBJÄLKAR	Scale	1:50
Material	70x140, 70x70, 43x140, 43x70	Date	04.12.2017
Drawer	RP	File	P5843-90 Edwin.dwg

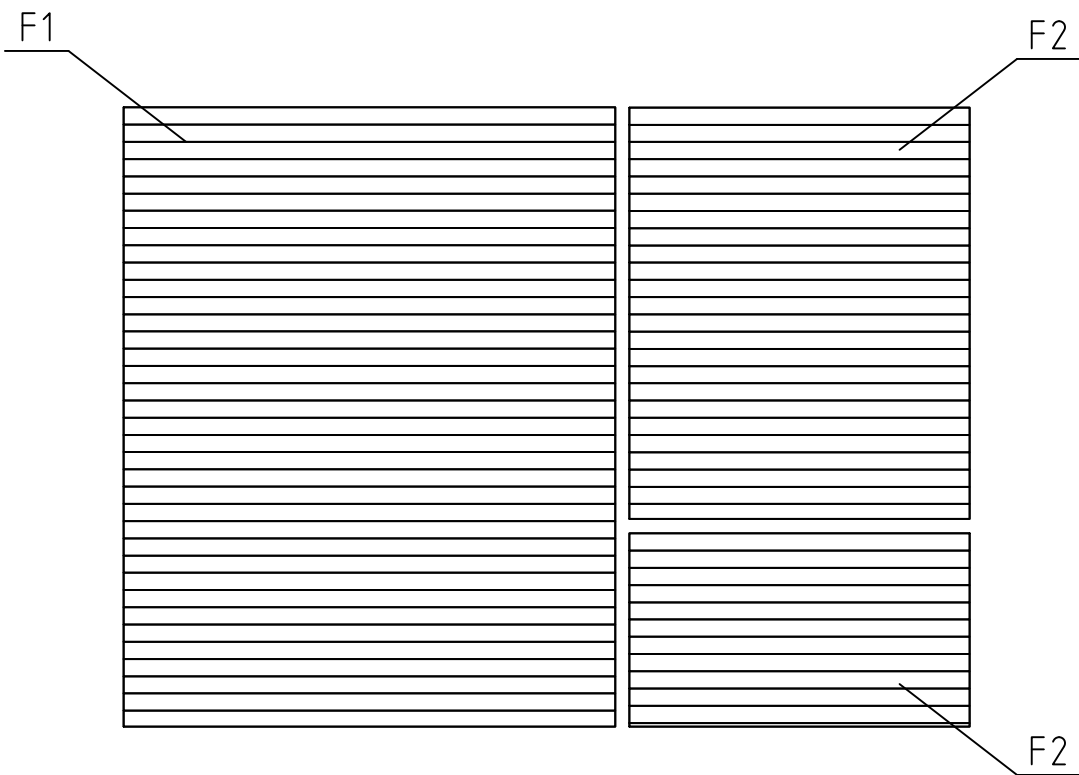

FLOORBOARD-LATTIALAUTA-GOLVBRÄDE

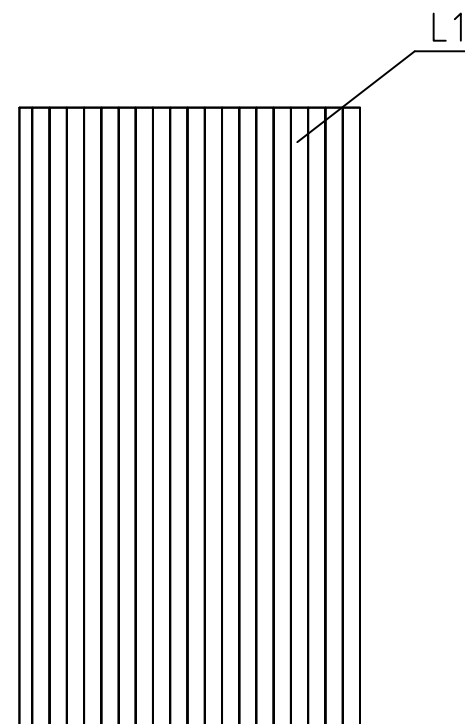

LOFT FLOORBOARD - PARVIA LATTIALATTIA - LOFT GOLVBRÄDE

House	P5843-90 Edwin	Sheet	6
Drawing	FLOORBOARD-LATTIALAUTA-GOLVBRÄDE	Scale	1:50
Material	28x114, 18x114	Date	04.12.2017
Drawer	RP	File	P5843-90 Edwin.dwg

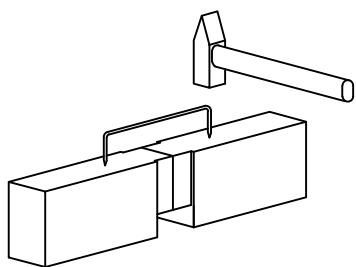
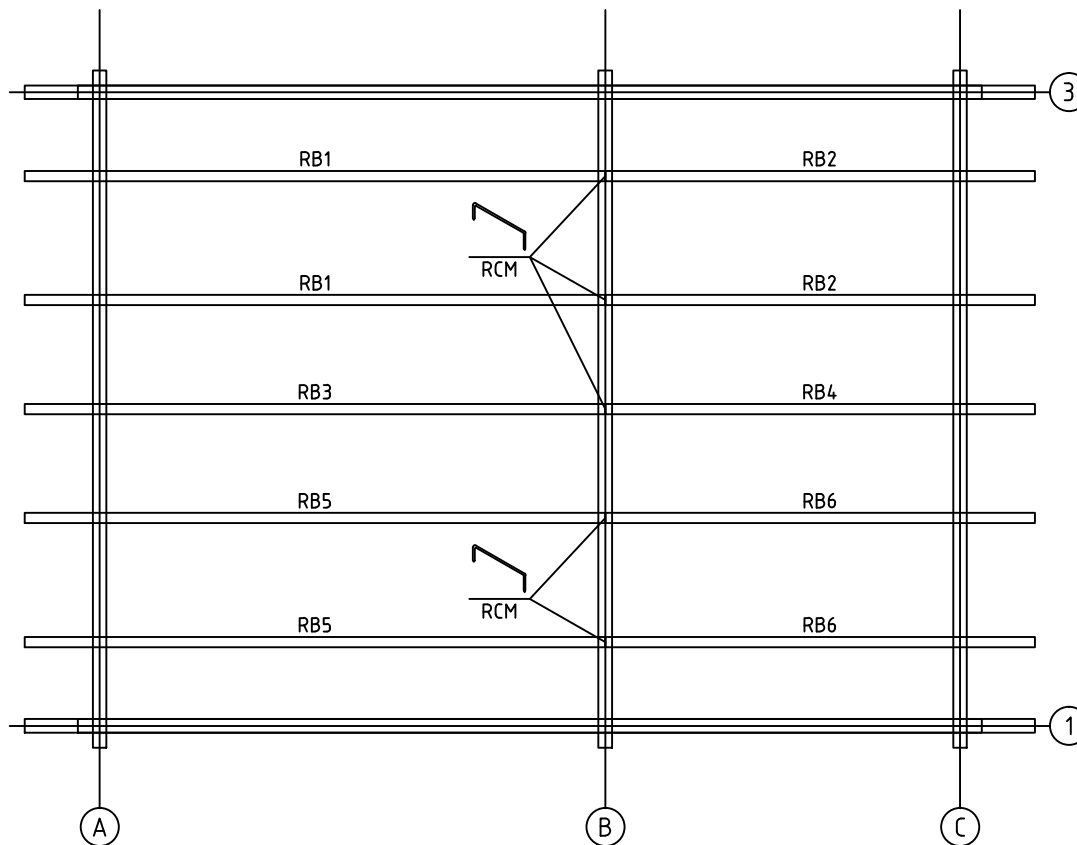

House	P5843-90 Edwin	Sheet	7
Drawing	PURLINS-KATTO-ORRET-TAKÅSAR	Scale	1:50
Material	68x190	Date	04.12.2017
Drawer	RP	File	P5843-90 Edwin.dwg

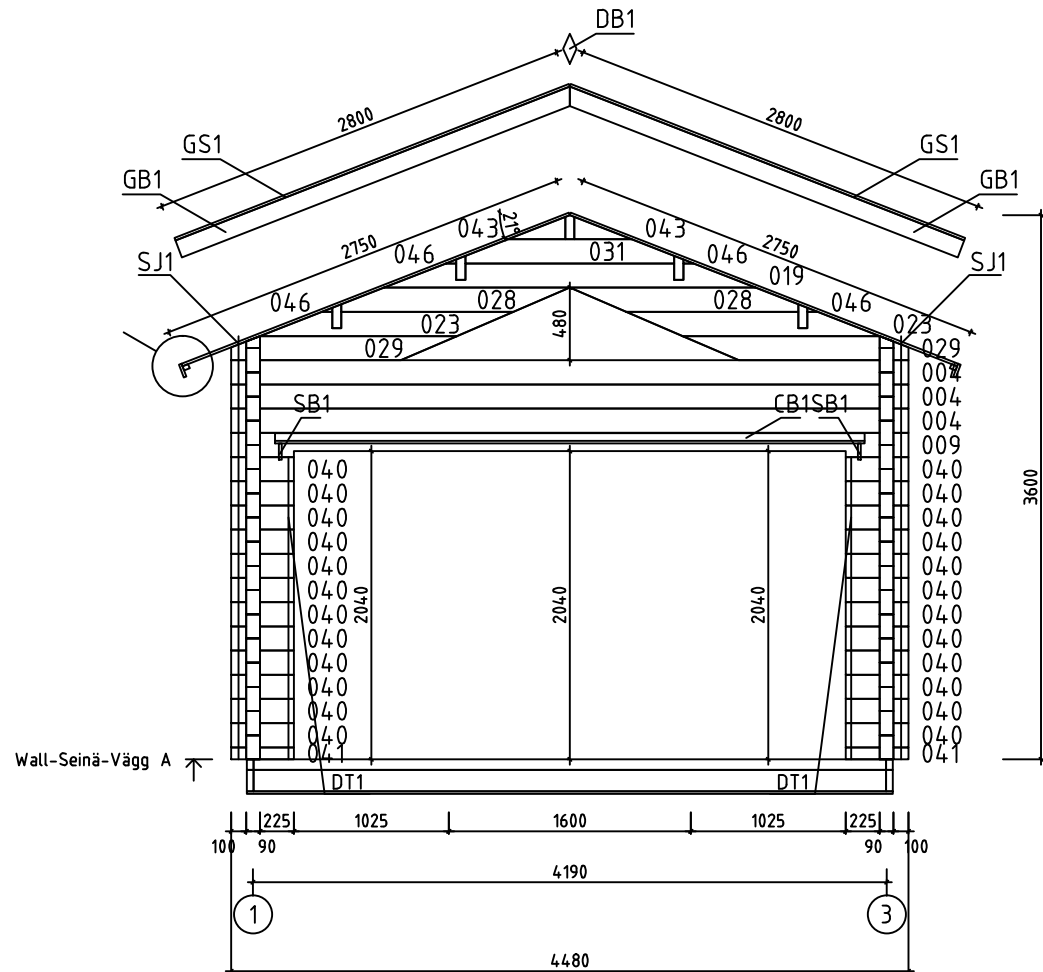
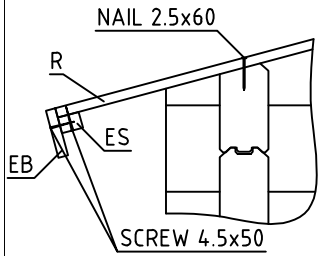

House	P5843-90 Edwin	Sheet	8
Drawing	WALL-SEINÄ-VÄGG A	Scale	1:50
Material	90x160	Date	04.12.2017
Drawer	RP	File	P5843-90 Edwin.dwg

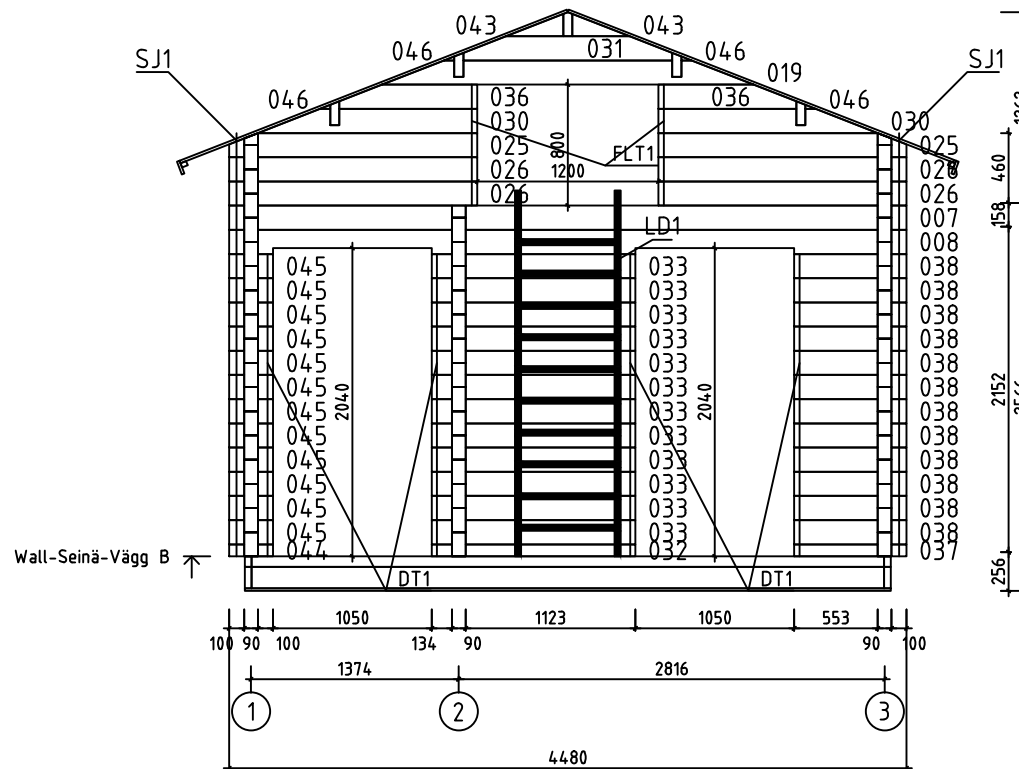

House	P5843-90 Edwin	Sheet	9
Drawing	WALL-SEINÄ-VÄGG B	Scale	1:50
Material	90x160	Date	04.12.2017
Drawer	RP	File	P5843-90 Edwin.dwg

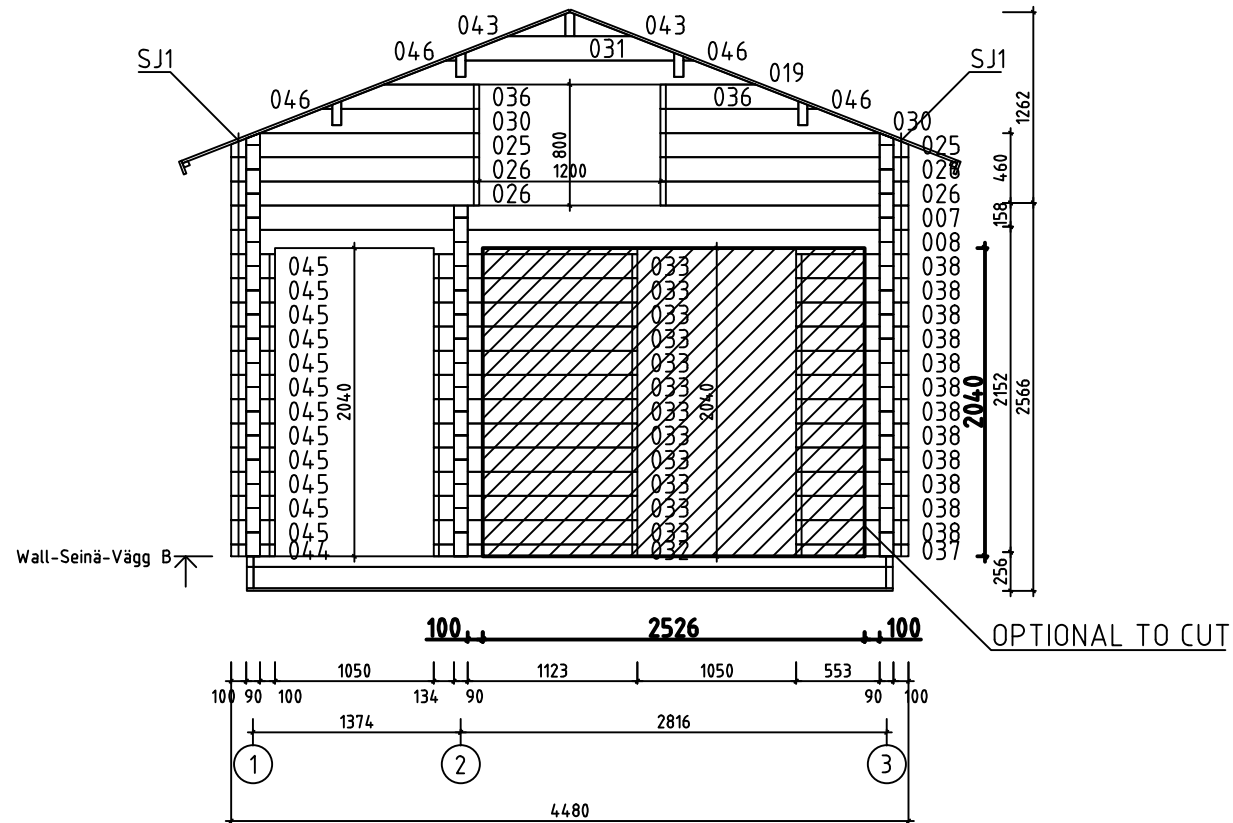

House	P5843-90 Edwin	Sheet	9A
Drawing	WALL-SEINÄ-VÄGG B	Scale	1:50
Material	90x160	Date	04.12.2017
Drawer	RP	File	P5843-90 Edwin Optional.dwg

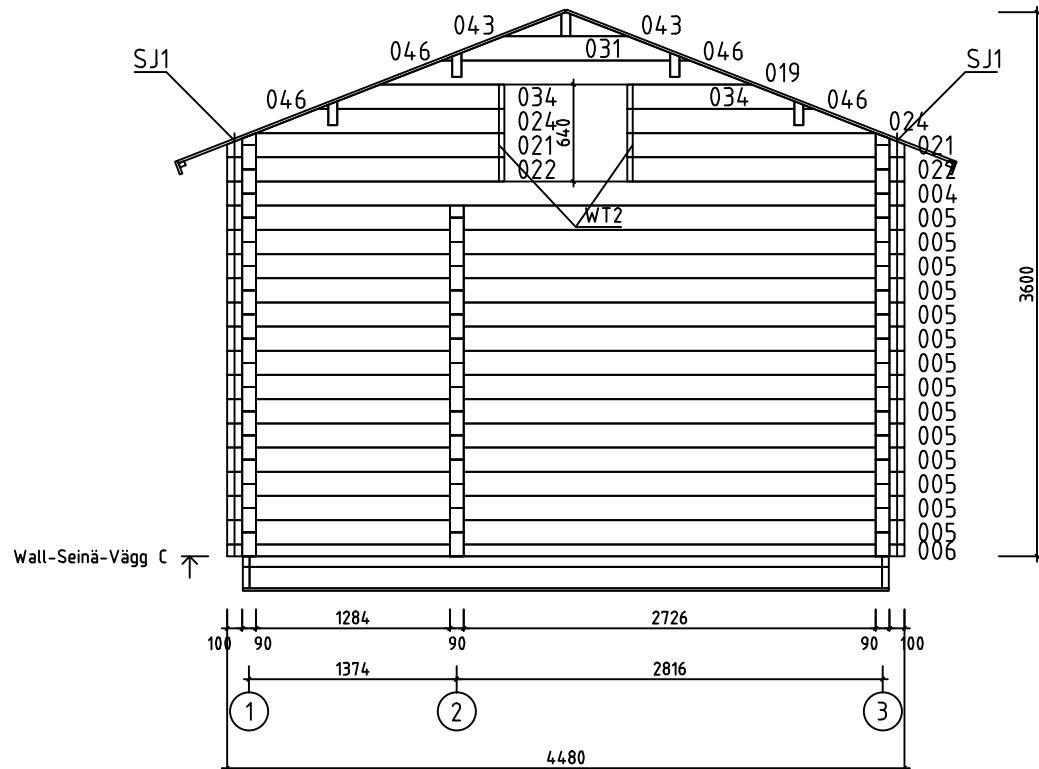

House	P5843-90 Edwin	Sheet	10
Drawing	WALL-SEINÄ-VÄGG C	Scale	1:50
Material	90x160	Date	04.12.2017
Drawer	RP	File	P5843-90 Edwin.dwg

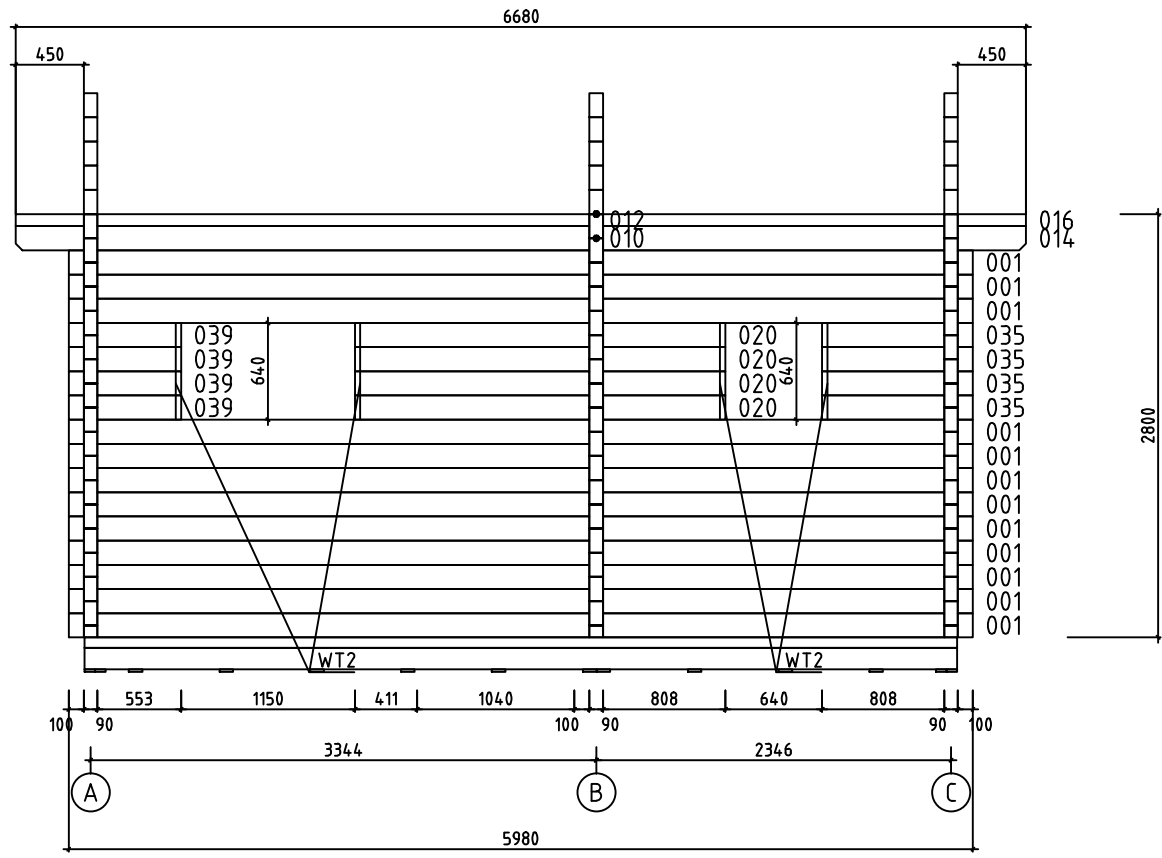

Wall-Seinä-Vägg 1 ↗

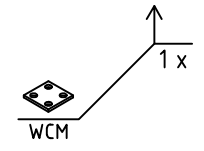
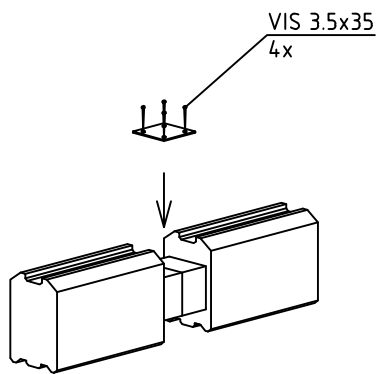

House	P5843-90 Edwin	Sheet	11
Drawing	WALL-SEINÄ-VÄGG 1	Scale	1:50
Material	90x160	Date	04.12.2017
Drawer	RP	File	P5843-90 Edwin.dwg

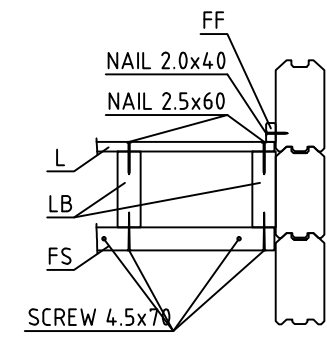
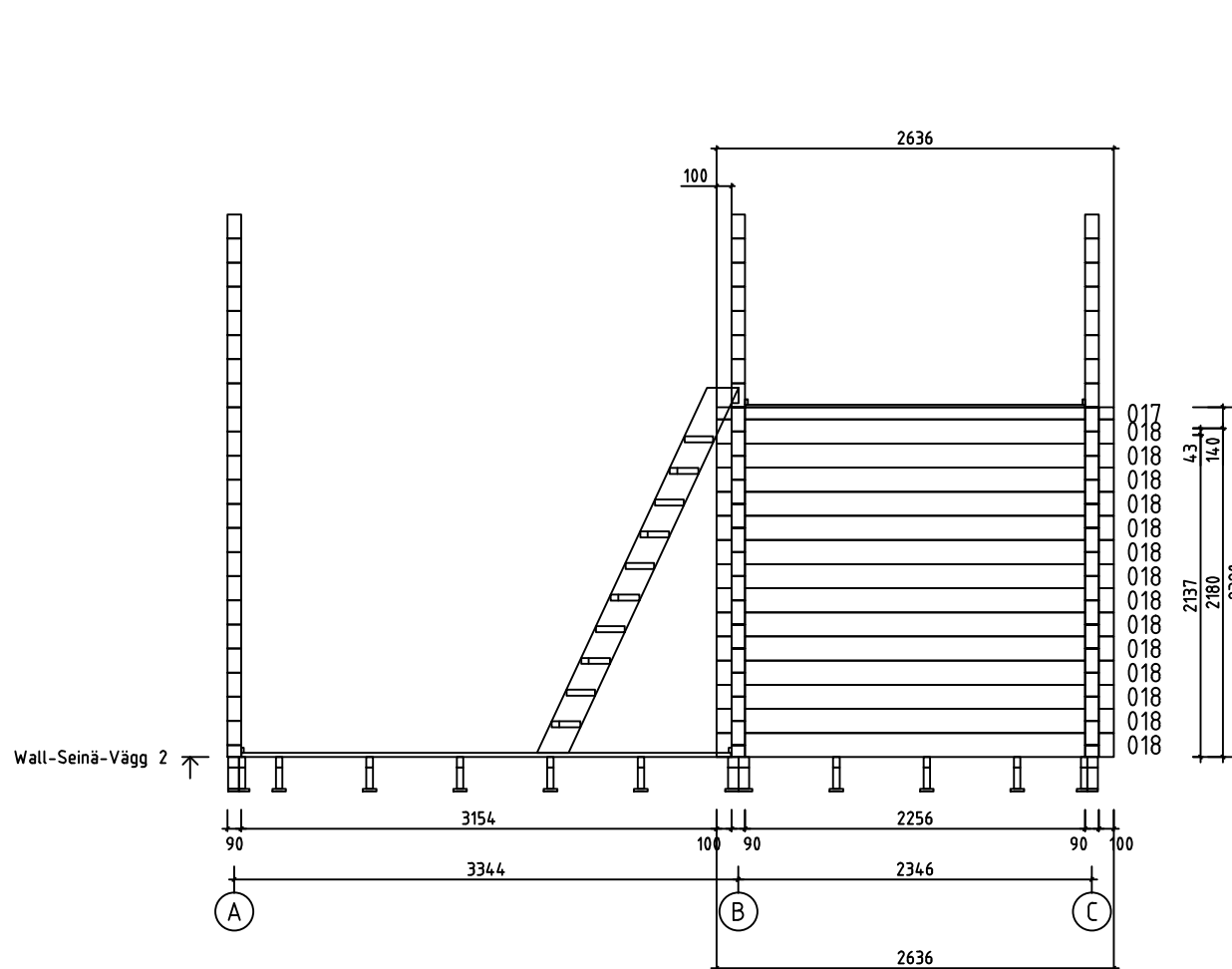

House	P5843-90 Edwin	Sheet	12
Drawing	WALL-SEINÄ-VÄGG 2	Scale	1:50
Material	90x160	Date	04.12.2017
Drawer	RP	File	P5843-90 Edwin.dwg

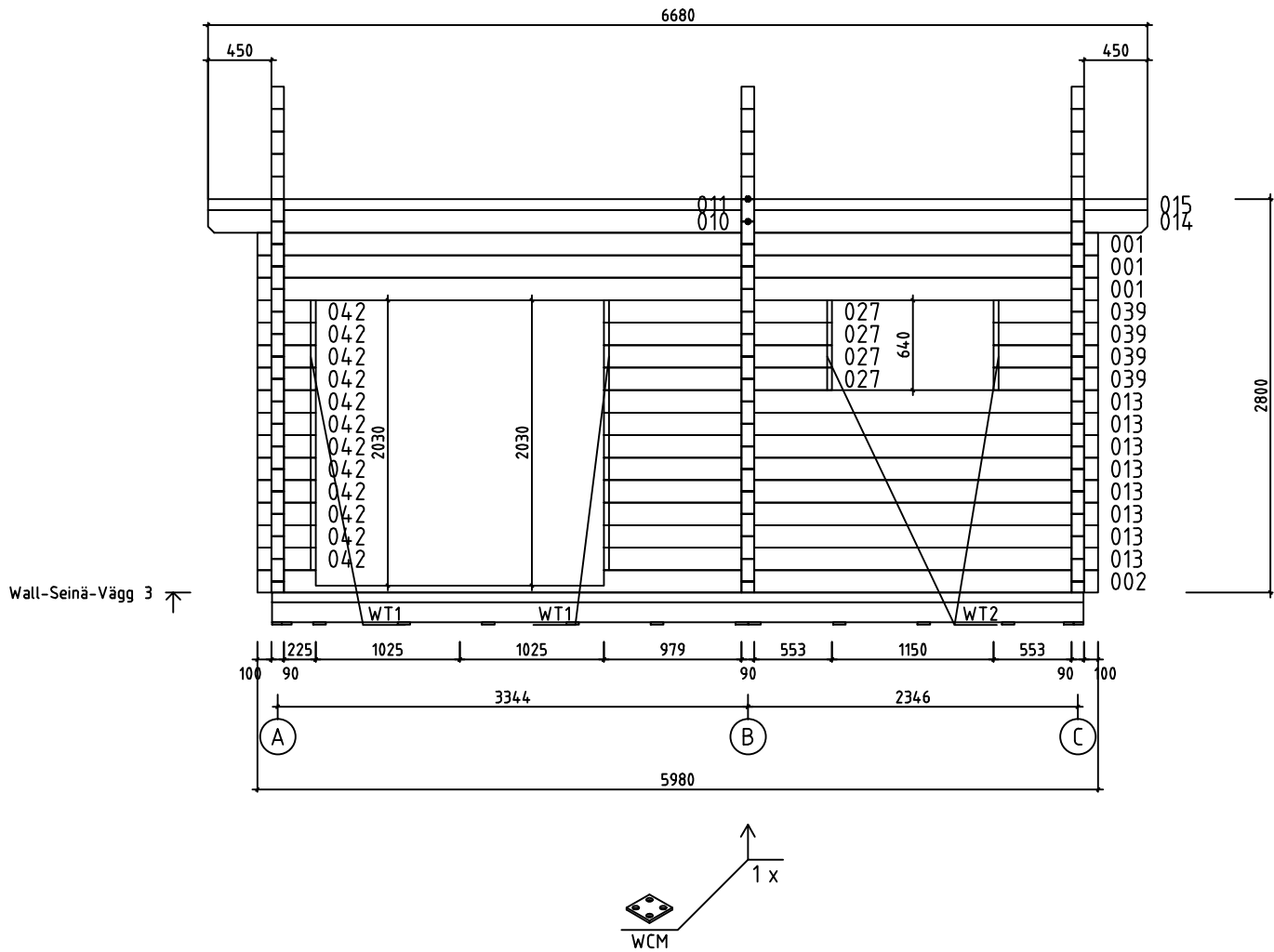



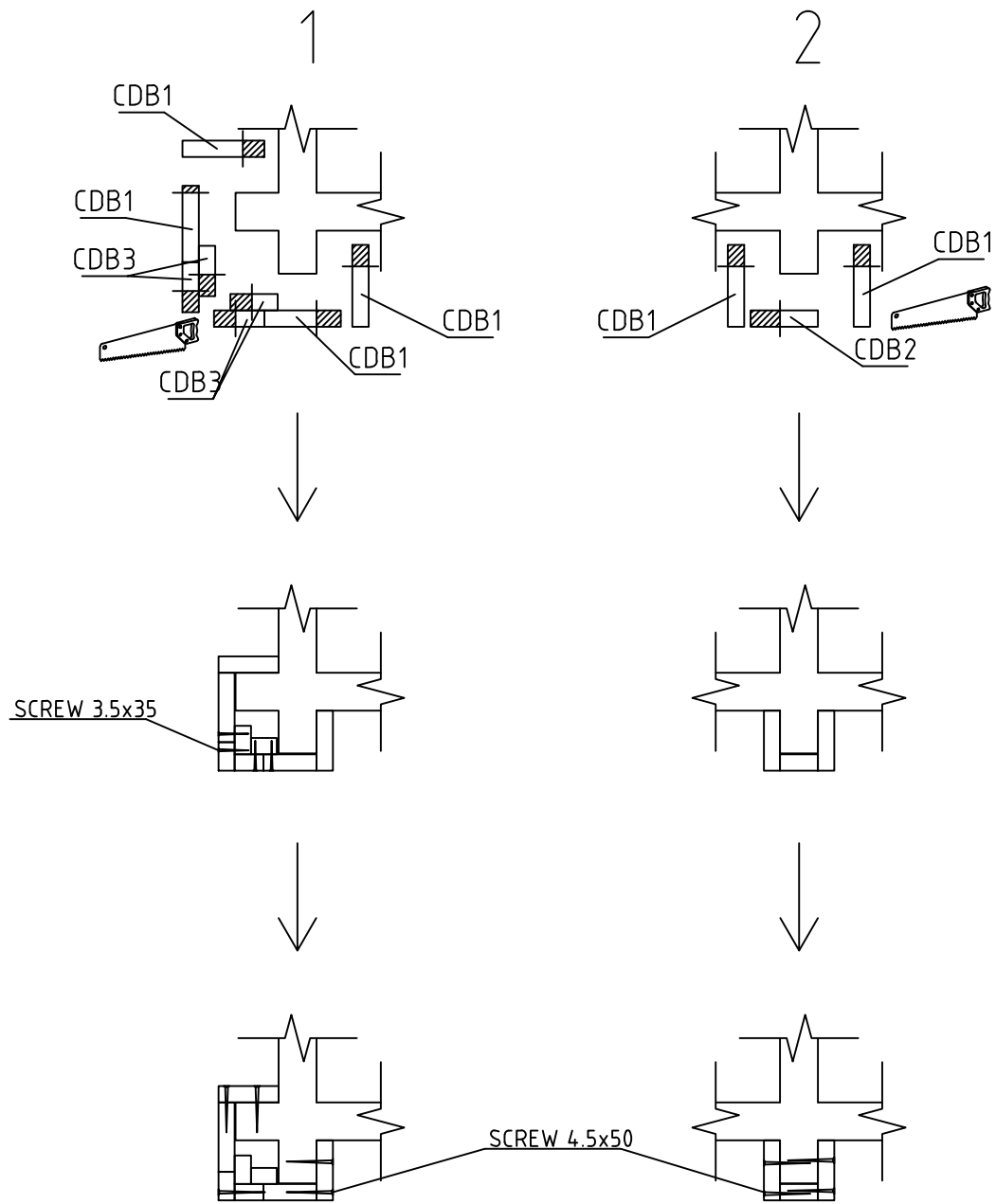
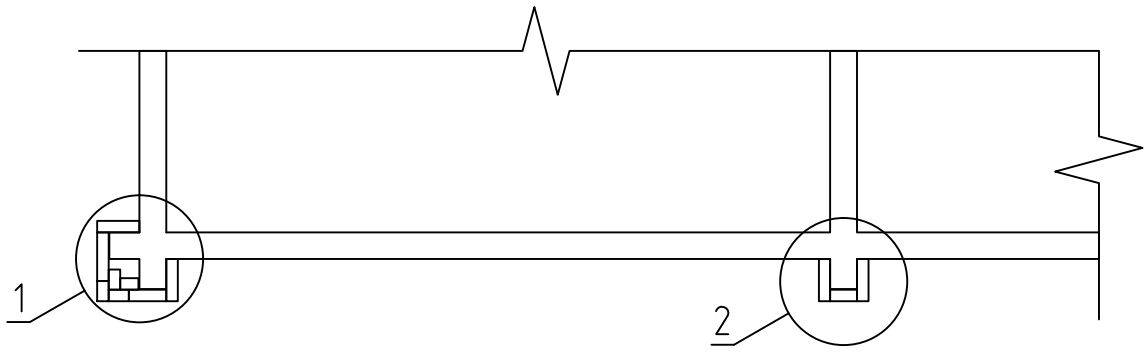



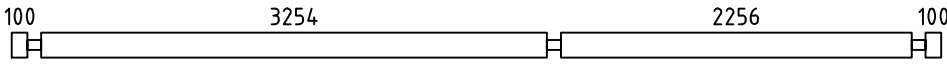
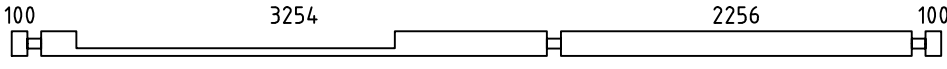
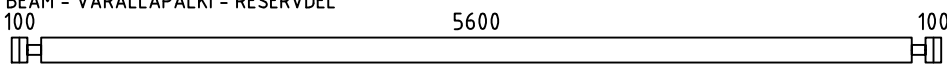
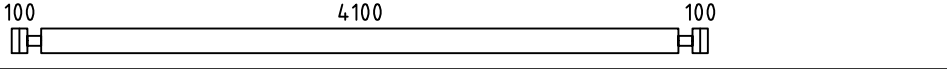
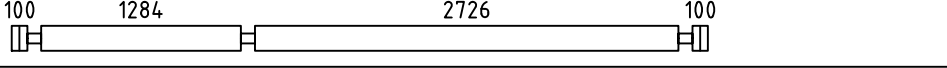
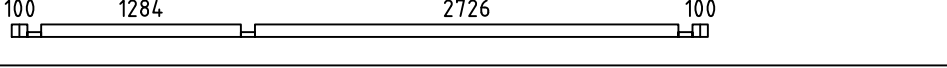
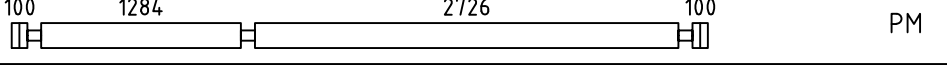
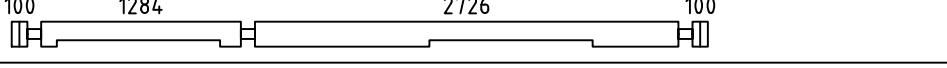
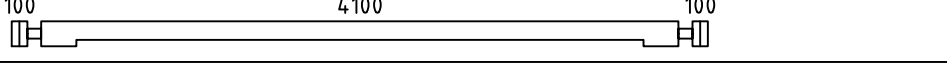
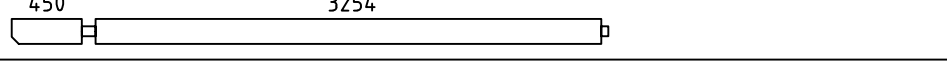
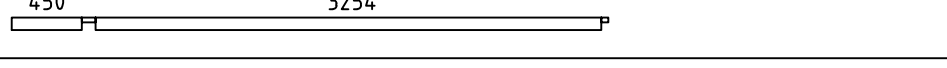
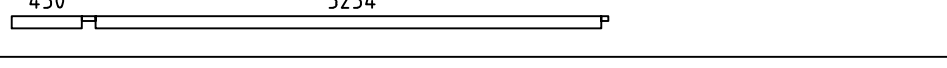
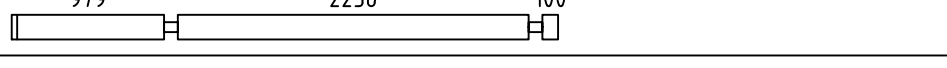
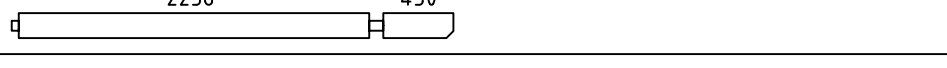
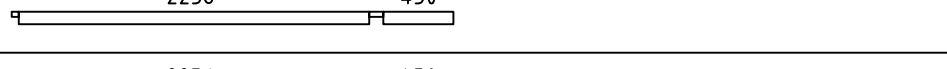
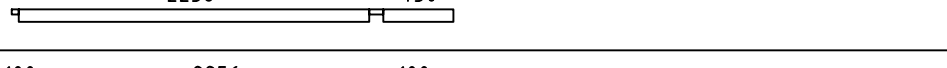
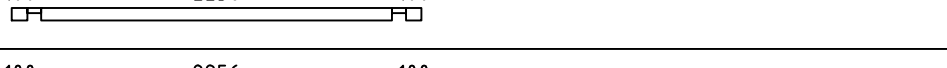
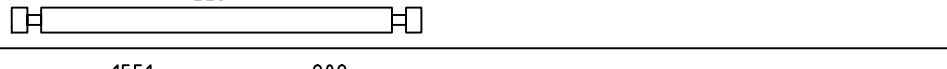
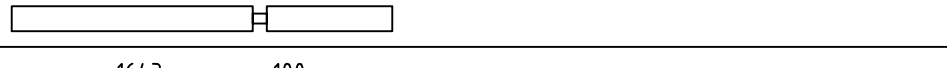
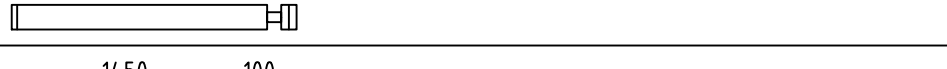
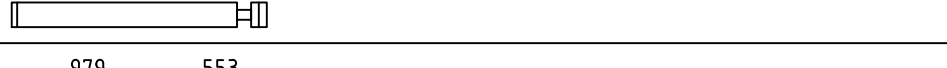
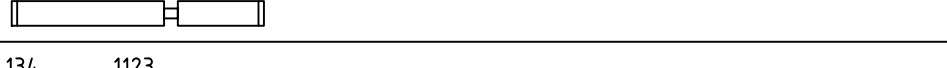
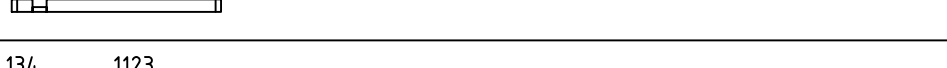
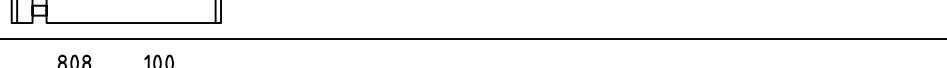
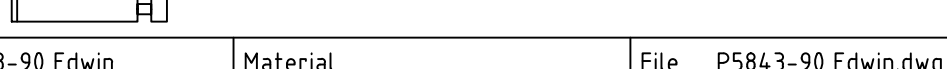

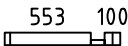
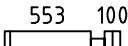
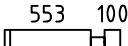





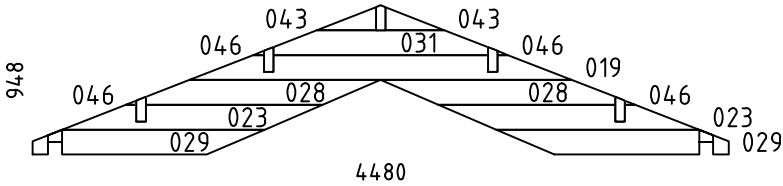
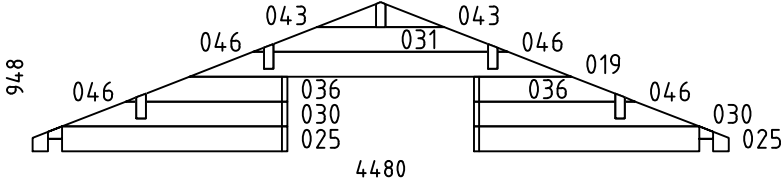
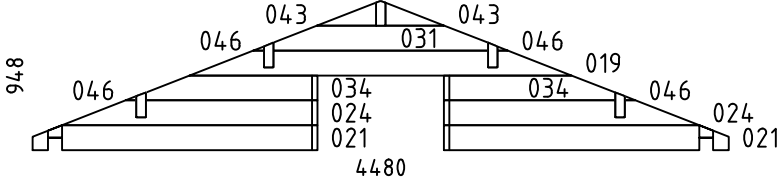

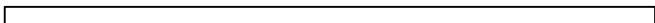
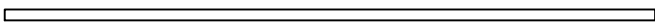
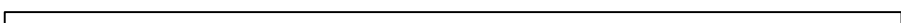

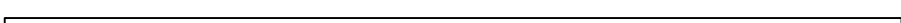
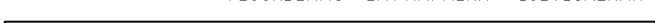





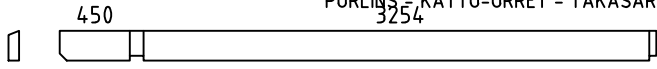
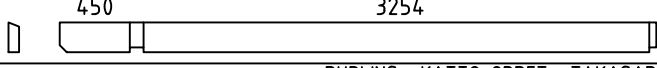
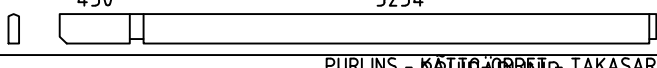
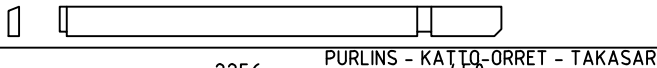
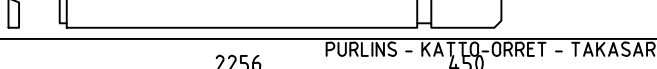



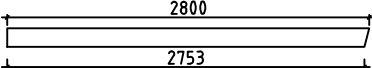

House	P5843-90 Edwin	Sheet	13
Drawing	WALL-SEINÄ-VÄGG 3	Scale	1:50
Material	90x160	Date	04.12.2017
Drawer	RP	File	P5843-90 Edwin.dwg













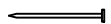

House	P5843-90 Edwin	Sheet	14
Drawing	CORNER DECORATION - HÖRN DEKORATION	Scale	1:50
Material		Date	04.12.2017
Drawer	RP	File	P5843-90 Edwin.dwg

Pos	P5843-90 Edwin	Pcs. St.	Profil(e) (mm)	L (mm)
001		15	90x160	5980
002		1	90x160	5980
003	SPARE BEAM - VARALLAPALKKI - RESERVDEL 	1	90x160	5980
004		4	90x160	4480
005		14	90x160	4480
006		1	90x80	4480
007		PM 1	90x160	4480
008		1	90x160	4480
009		1	90x160	4480
010		2	90x160	3839
011		1	90x80	3839
012		1	90x80	3839
013		8	90x160	3515
014		2	90x160	2841
015		1	90x80	2841
016		1	90x80	2841
017		1	90x80	2636
018		14	90x160	2636
020		4	90x160	2449
022		2	90x160	1833
026		4	90x160	1640
027		4	90x160	1622
032		1	90x80	1347
033		12	90x160	1347
035		4	90x160	998
House P5843-90 Edwin		Material	File P5843-90 Edwin.dwg	Sheet 15

Pos	P5843-90 Edwin	Pcs. St.	Profil(e) (mm)	L (mm)
037		1	90x80	743
038		12	90x160	743
039		8	90x160	743
040		24	90x160	415
041		2	90x80	415
042		12	90x160	415
044		1	90x80	290
045		12	90x160	290
WA-1		1	90x948	4480
WB-1		1	90x948	4480
WC-1		1	90x948	4480
HB	HIT BLOCK-ASENNUSPALKI-SLAG BRÄDA 	2	90x160	300
LB1	LOFT FLOOR BEAMS-PARVIAPALKIT-LOFTBJÄLKAR 	11	43x140	2250
FB1	FLOORBEAMS - LATTIAPALKIT - GOLVBJÄLKAR 	4	70x140	4184
FB2	FLOORBEAMS - LATTIAPALKIT - GOLVBJÄLKAR 	4	70x70	4184
FB5	FLOORBEAMS - LATTIAPALKIT - GOLVBJÄLKAR 	2	43x140	5770
FB3	FLOORBEAMS - LATTIAPALKIT - GOLVBJÄLKAR 	10	43x140	4184
FB6	FLOORBEAMS - LATTIAPALKIT - GOLVBJÄLKAR 	2	43x70	5770
FB4	FLOORBEAMS - LATTIAPALKIT - GOLVBJÄLKAR 	10	43x70	4184
House	P5843-90 Edwin	Material	File	P5843-90 Edwin.dwg
			Sheet	16

Pos	P5843-90 Edwin		Pcs. St.	Profil(e) (mm)	L (mm)
BB2	COUNTERFLOOR HOLDING BOARDS - ROSSIPOHJAA KANNATTELEVAT LAUDAT - BRÄDER SOM HALLER TROSSBOTTEN		10	90x18	4270
BB1	COUNTERFLOOR HOLDING BOARDS - ROSSIPOHJAA KANNATTELEVAT LAUDAT - BRÄDER SOM HALLER TROSSBOTTEN		4	70x18	4270
FS2	SLEEPING FLOOR SUPPORTING SLAT - PARVIALATTIA TUKILISTA - LOFTGOLVLIST		2	43x43	2720
FS1	SLEEPING FLOOR SUPPORTING SLAT - PARVIALATTIA TUKILISTA - LOFTGOLVLIST		2	43x43	1280
RB5	 PURLINS - KATTO-ORRET - TAKASAR 3254		2	68x190	3839
RB1	 PURLINS - KATTO-ORRET - TAKASAR 3254		2	68x190	3839
RB3	 PURLINS - KATTO-ORRET - TAKASAR 3254		1	68x190	3839
RB6	 PURLINS - KATTO-ORRET - TAKASAR 450		2	68x190	2841
RB2	 PURLINS - KATTO-ORRET - TAKASAR 450		2	68x190	2841
RB4	 PURLINS - KATTO-ORRET - TAKASAR 450		1	68x190	2841
F1	FLOORBOARD - LATTIALAUTA - GOLVBRÄDE	 114 or -tai- eller 88	36+1 47+1	28x114 28x88	3250
F2	FLOORBOARD - LATTIALAUTA - GOLVBRÄDE	 114 or -tai- eller 88	36+1 47+1	28x114 28x88	2250
L1	LOFT BOARD - PARVIALATTIA - LOFTGOLV	 114 or -tai- eller 88	20+1 26+1	18x114 18x88	4095
R1	ROOFBOARD - KATTOLAUTA - TAKBRÄDE	 114 or -tai- eller 88	118+2 154+2	18x114 18x88	2750
FF1	SKIRTING SLAT - LATTIALISTA - GOLVLIST			18x35	45m
GB1	GABLE BOARD - KAAPELILAUTA - GAVELBRÄDA		4	18x120	2800
GS1	BOARD MATCHING WITH GABLE BOARD - KAAPELILAUTA VASTAVA LAUTA - BRÄDA OVPÅ GAVELBRÄDA		4	18x70	2800
EB1	EAVE BOARD - RÄYSTÄSLAUTA - TAKFOTBRÄDE		4	18x90	3340
ES1	EAVE SLAT - RÄYSTÄSLISTA - TAKFOTLIST		4	30x40	3340
DB1	DECORATIVE - KORISTE - PRYDNADS		2	18x90	200
CDB1	CORNER DECORATION BOARD - HÖRN DEKORATION BRÄDE		22	120x18	2790
CDB2	CORNER DECORATION BOARD - HÖRN DEKORATION BRÄDE		3	90x18	2790
CDB3	CORNER DECORATION BOARD - HÖRN DEKORATION BRÄDE		16	70x18	2790
CB1	COVERING BOARD - PEITELAUTA - HYLLBRÄDA		1	18x120	3900
SB1	SUPPORT BOARD - TUKILAUTA - KONSOL		2	28x85	80
DT1	DOOR ASSEMBLING PROFILE - VEN ASENNUSPROFIILI - DÖRR MONTERINGSPROFIL		6	90x43	1950
House	P5843-90 Edwin	Material	File	P5843-90 Edwin.dwg	Sheet 17

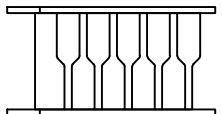
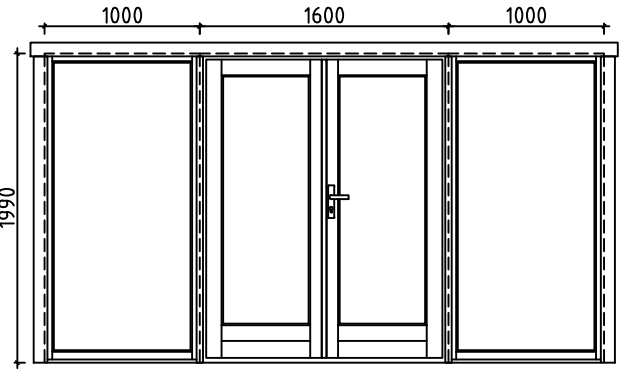
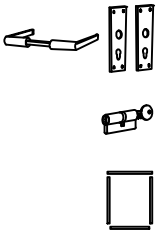
Pos	P5843-90 Edwin		Pcs. St.	Profil(e) (mm)	L (mm)
WT1	WINDOW ASSEMBLING PROFILE - IKKUNA ASENNUSPROFILI - FÖNSTER MONTERINGSPROFIL		2	90x43	1870
WT2	WINDOW ASSEMBLING PROFILE - IKKUNA ASENNUSPROFILI - FÖNSTER MONTERINGSPROFIL		8	90x43	590
FLT1	ASSEMBLING PROFILE-ASENNUSPROFILI-MONTERINGSPROFIL		2	18x25	760
SJ1	SCREW JOINT - KIERRETANKO - GÄNGSTAPP		6	M10	2770
RCM	ROOFBEAMS CONNECTING METAL - METALL FÖR SAMMANFOGNING AV TAKASAR - KATTO-ORRE YHTEENLITYSMETALLT		5	∅6.0	200
WCM	WALLBEAMS CONNECTING METAL - METALLPLATTA FÖR SAMMANFOGNING AV VÄGGEN BALKAR - SEINÄPALKKEJA METALLISET YHTEENLIITYMISLAATAT		2	60	60
	NAILS-NAULAT-SPIKAR FOR-VARTEN-FÖR FF1		110	∅2.0	40
	NAILS-NAULAT-SPIKAR FOR-VARTEN-FÖR F1, F2, L1, R1, BB1, BB2		1600	∅2.5	60
	SCREWS-RUUVIT-SKRUVAR FOR-VARTEN-FÖR WCM, CDB3		100	∅3.5	35
	SCREWS-RUUVIT-SKRUVAR FOR-VARTEN-FÖR GB1, GS1, EB1, ES1, DB1, CB, CDB1, CDB2		280	∅4.5	50
	SCREWS-RUUVIT-SKRUVAR FOR-VARTEN-FÖR FS1, FS2, LB1, SB		50	∅4.5	70
	SCREWS-RUUVIT-SKRUVAR FOR-VARTEN-FÖR FB1, FB2, FB3, FB4, FB5, FB6		60	∅4.5	90
	SCREWS-RUUVIT-SKRUVAR FOR-VARTEN-FÖR 006, 011, 012, 015, 016, 017, 032, 037, 041, 044, FB2, FB4, FB6		80	∅5.0	120
	SCREWS-RUUVIT-SKRUVAR FOR-VARTEN-FÖR RB1, RB2, RB3, RB4, RB5, RB6		20	∅6.0	160
LD1	LADDER-TIKAPUUT-STEGE		1	700	2760
D1	DOOR-OVI-DÖRR (right-oikea-höger) ORT_ST	P	1	1600	1990
W1	WINDOW-IKKUNAN-FÖNSTER ORT_ST_K		2	1000	1990
			1		
			1		
			1		

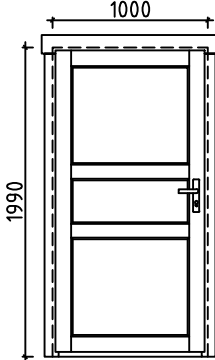
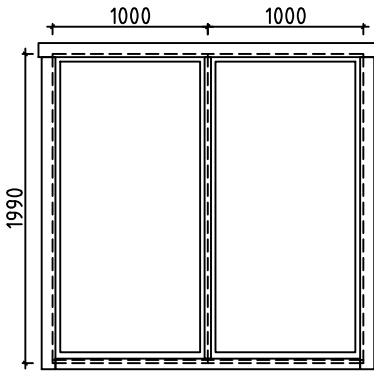
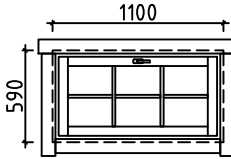
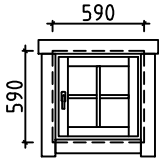
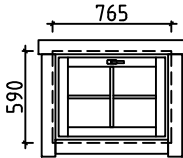
Pos	P5843-90 Edwin	Pcs. St.	Profil(e) (mm)	L (mm)		
D2	DOOR-OVI-DÖRR (left-jäljellä-vänster) AST 	V 2 2 2	1000	1990		
W2	WINDOW-IKKUNAN-FÖNSTER ORT_ST_K 	2	1000	1990		
W3	WINDOW-IKKUNAN-FÖNSTER ORT_ST_SU 	P 2 2 2	1100	590		
W4	WINDOW-IKKUNAN-FÖNSTER (right-oikea-höger) ORT_ST 	P 1 1 1	590	590		
W5	WINDOW-IKKUNAN-FÖNSTER ORT_ST_SU 	1 1 1 1	765	590		
House	P5843-90 Edwin	Material	File	P5843-90 Edwin.dwg	Sheet	19

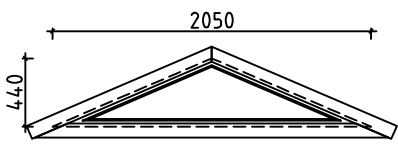
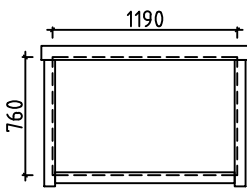
Pos	P5843-90 Edwin	Pcs. St.	Profil(e) (mm)	L (mm)
W6	WINDOW-IKKUNAN-FÖNSTER ORT_ST_K 	1	2050	440
FL1	FRAME AROUND LOFT ENTRANCE 	1	1190	760

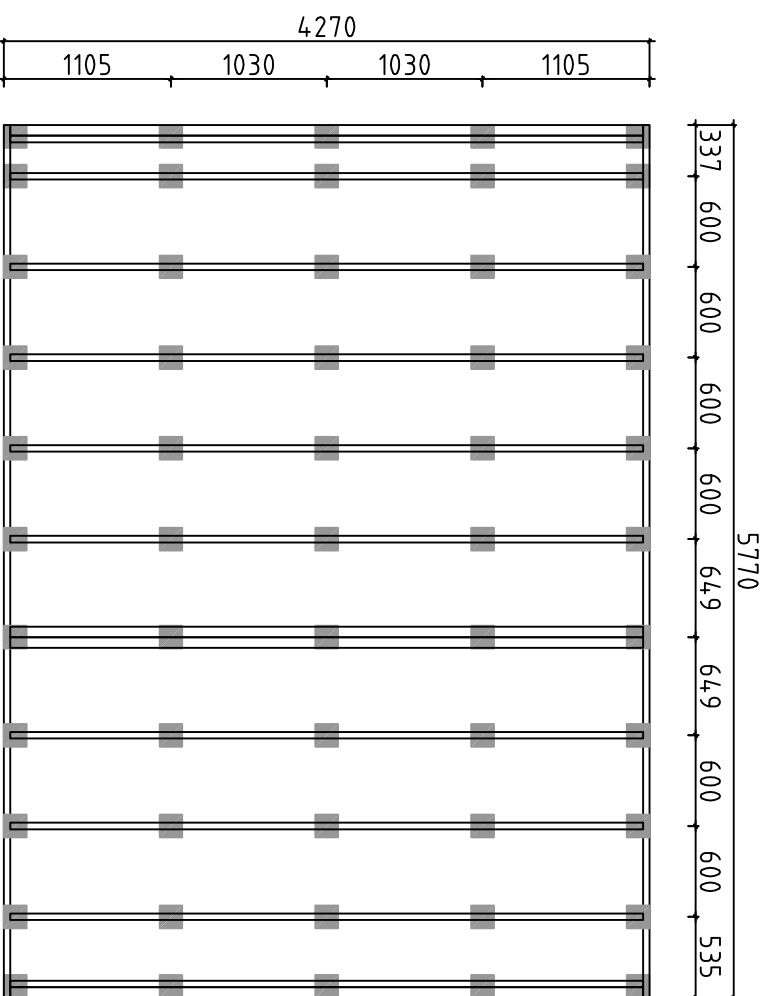

Detta är ett förslag för hur man kan placera plintarna (100-200 mm i diameter) för golvbjälklaget. Golvbjälkarna är med i byggsatsen, men inte plintarna. Använder man exempelvis 500-600mm långa murblock så kan man halvera antalet punkter. Lägg fuktskyddande papp mellan betong och trä

Tämä on ehdotus siitä, miten (100-200 mm läpimittaiset) jalat voidaan sijoittaa alapohjaa varten. Lattiapalkit ovat rakennussarjassa, mutta jalat ei ole. Kun käytetään esimerkiksi 500-600 mm pitkiä harkkoja, voidaan pisteiden määrä puoltaa. Aseta betonin ja puun väliin kosteudelta suojava pahvi

A proposal for placing plinths (100-200 mm in diameter) for floor beams. Floor beams are provided in the kit but plinths are not included. For example, by using 500-600 mm long masonry units, one can reduce the number of points 50%. Place cardboard between the concrete and wood to protect from moisture

House	P5843-90 Edwin	Sheet	21
Drawing	FOUNDATION PLAN - PLINTPLAN	Scale	1:50
Material		Date	04.12.2017
Drawer	RP	File	P5843-90 Edwin Foundation.dwg

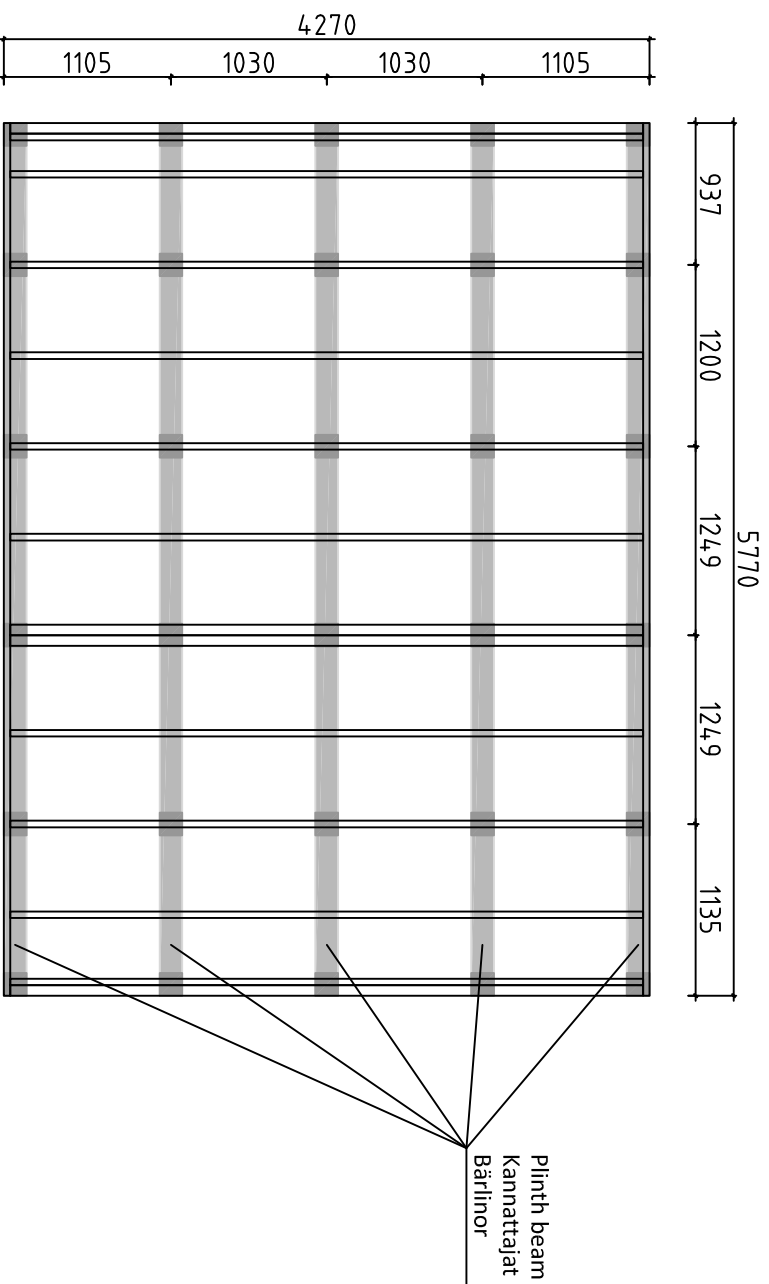

Förslag på alternativ plintplan med bärlnor och plintar. Bärlnor 45x95 eller 45x120 och plintar ca 100-200 mm i diameter. (Bärlnor och plintar ingår ej i leveransen). Används exempelvis murblock, (ingår ej i leveransen) istället för plintar, kan man lägga bärlnorra platt mot dessa och på det sättet minska höjden på konstruktionen. I denna konstruktion kan man dessutom lägga en "boardskiva" mellan bärlnorra och golvbjälkarna och på det sättet bära upp bjälklagsisoleringen. Lagg fuktskyddande papp mellan betong och trä

Endotus valtoehtoisestä jalustasta kannattajilla ja jalolla. Kannattajat 45x95 tai 45x120 ja jalat läpimitataan n. 100-200 mm (kannattajat ja jalat ei ole toimituksessa). Käytettäessä esimerkiksi harkkoja (ei kuulu toimitukseen) jalkojen sijasta, voi kannattajat asettaa lappeelleen niitä vasten ja sillä tavoin vähentää rakenteen korkeutta. Tässä rakenteessa voi lisäksi asettaa levyn kannattajien ja lattiapalkkien väliin ja sillä tavoin kannattaa alapohjan eristystä. Aseta betonin ja puun väliin kosteudelta suojaava pahvi

A proposal for alternative plinth beam layout plan. Plinth beams 45x95 or 45x120 and plinths ca 100-200 mm in diameter (plinth beams and plinths are not included in the kit). For example, by using masonry units (not included in the kit) instead of plinths, one can lay plinth beams flat against the masonry units and in that way reduce the height of the structure. In this construction one can also add "plywood board" between plinth beams. Place cardboard between the concrete and wood to protect from moisture

House	P5843-90 Edwin	Sheet	22
Drawing	FOUNDATION PLAN - PLINTPLAN	Scale	1:50
Material		Date	04.12.2017
Drawer	RP	File	P5843-90 Edwin Foundation.dwg

#001	1,3	5980	15
#002	3	5980	1
#003		5980	1
#004	A,C	4480	4
#005	C	4480	14
#006	C	4480	1
#007	B	4480	1
#008	B	4480	1
#009	A	4480	1
#010	1,3	3839	2
#011	3	3839	1
#012	1	3839	1
#013	3	3515	8
#014	1,3	2841	2
#015	3	2841	1
#016	1	2841	1
#017	2	2636	1
#018	2	2636	14
#019	A,B,C	2460	3
#020	1	2449	4
#021	C	1833	2
#022	C	1833	2
#023	A	1677	2
#024	C	1643	2
#025	B	1640	2
#026	B	1640	4
#027	3	1622	4
#028	A	1511	2
#029	A	1495	2
#030	B	1450	2
#031	A,B,C	1382	3
#032	B	1347	1
#033	B	1347	12
#034	C	1104	2
#035	1	998	4
#036	B	911	2
#037	B	743	1
#038	B	743	12
#039	1,3	743	8
#040	A	415	24
#041	A	415	2
#042	3	415	12
#043	A,B,C	380	6
#044	B	290	1
#045	B	290	12
#046	A,B,C	69	12