

001 / 2

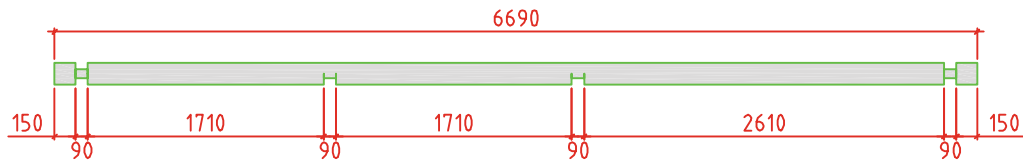

002 / 1

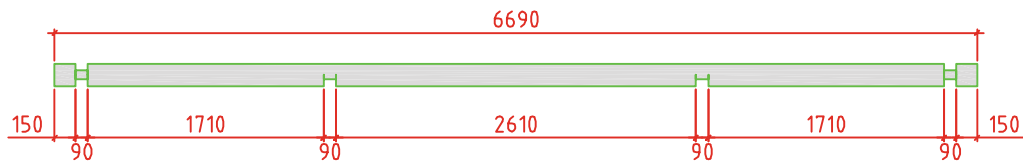

003 / 1

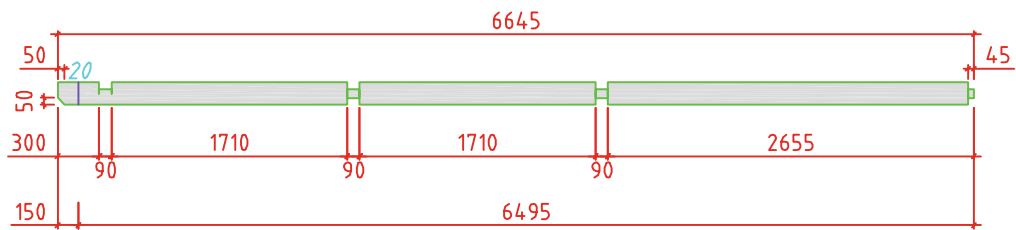

004 / 1



005 / 2

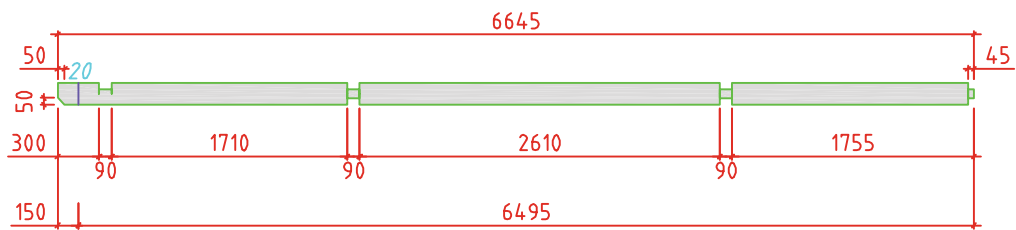

006 / 1

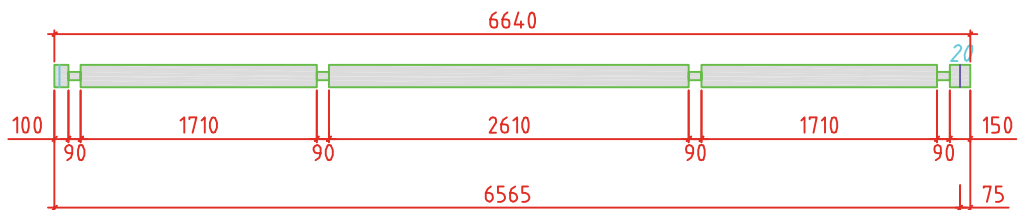

007 / 1

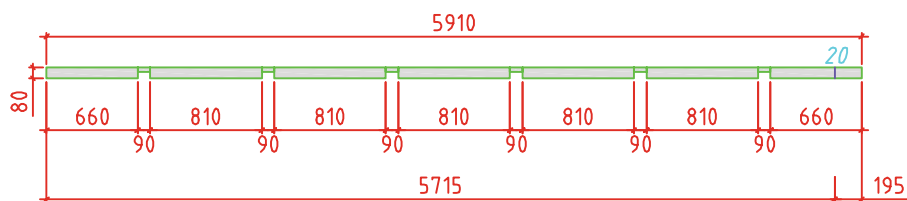

008 / 2

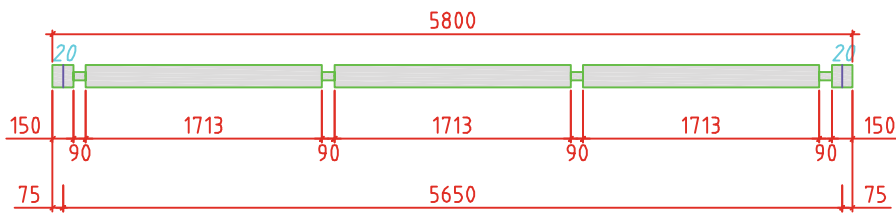

009 /14

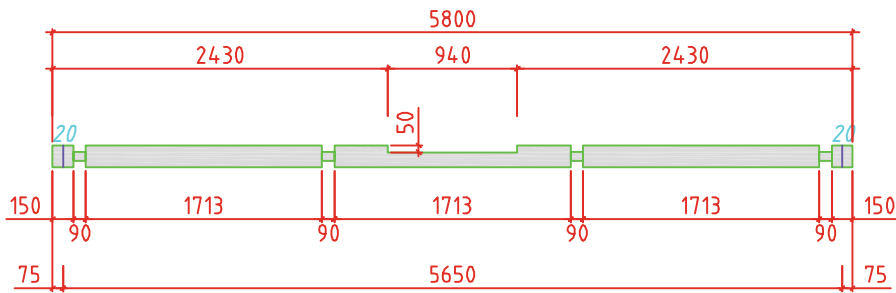

010 /1

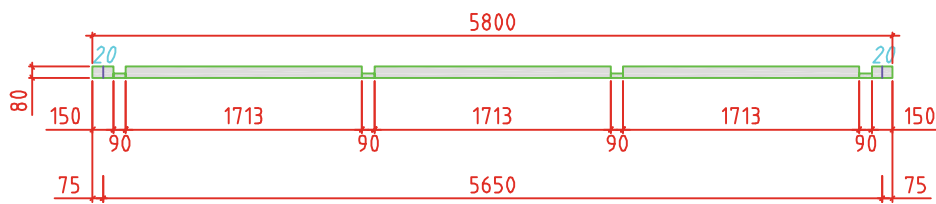

011 /2

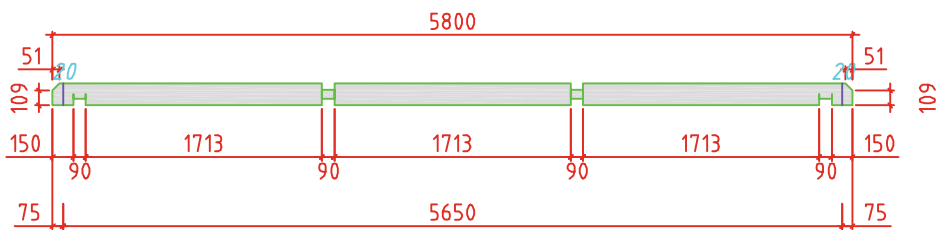

012 /1

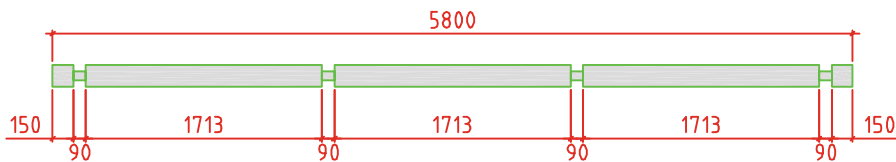

013 /3

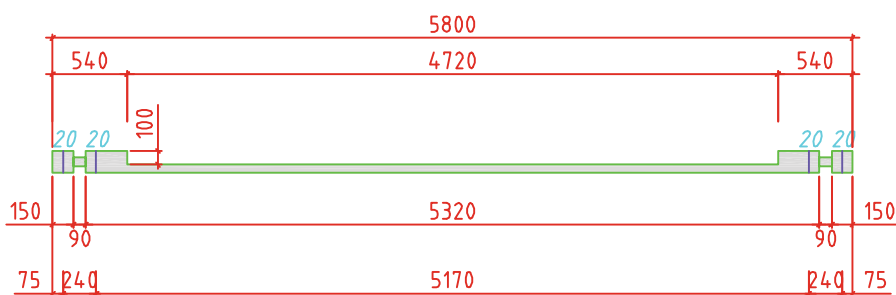

014 /1

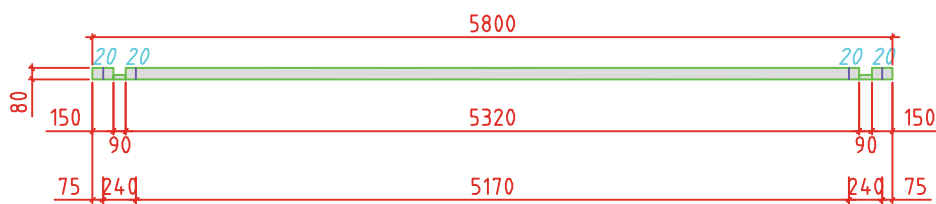

015 /1

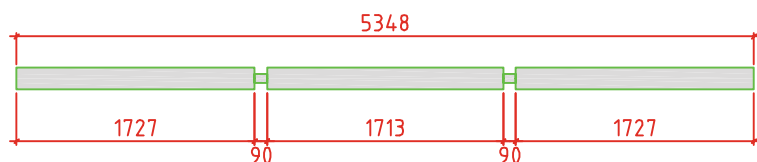

016 /1

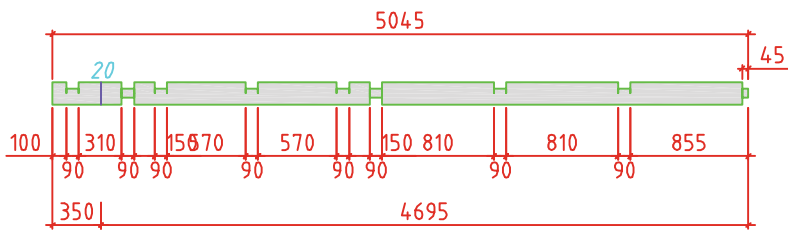

017 /1

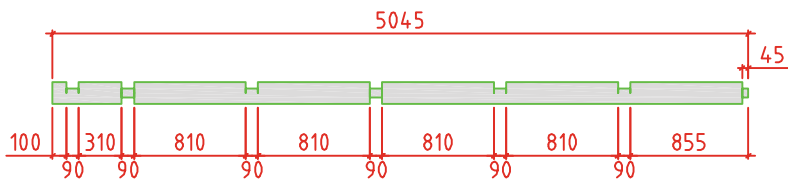

018 /1

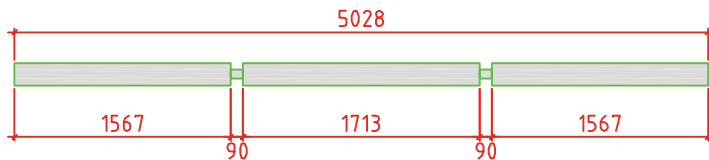

019 /1

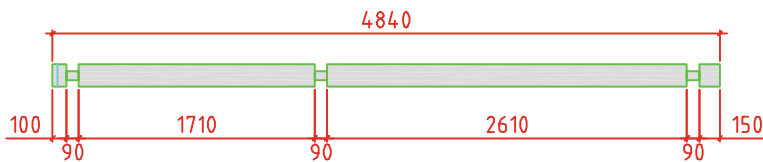

020 /6

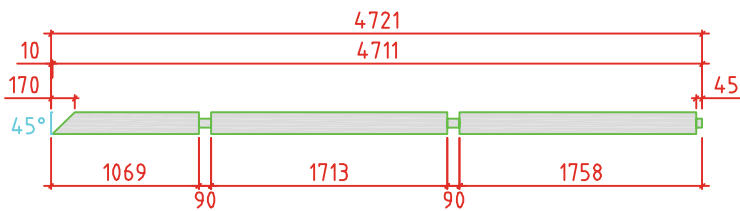

021 /3
To cut of a thorn

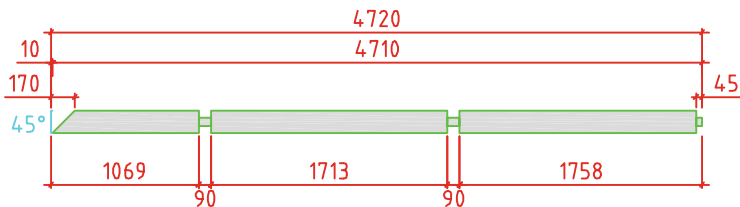

022 /4
To cut of a thorn

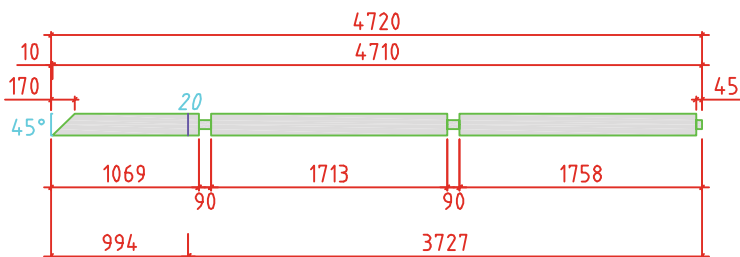

023 /2

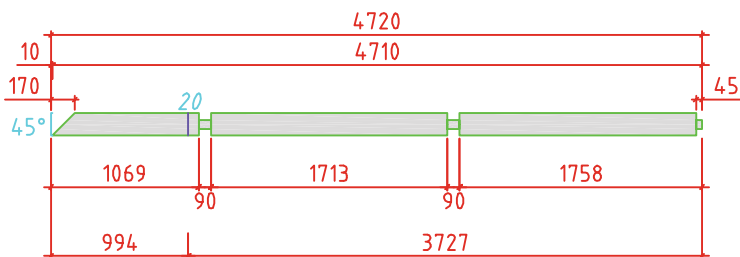

024 /3
To cut of a thorn

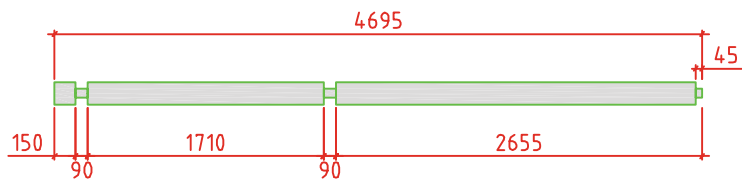

025 /7

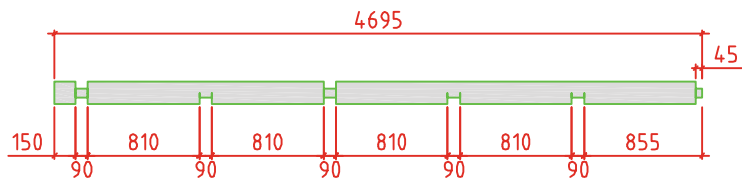

026 /1

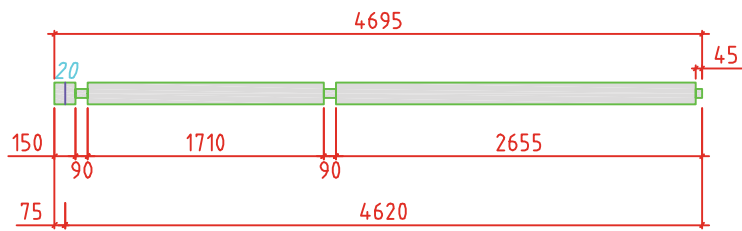

027 /1

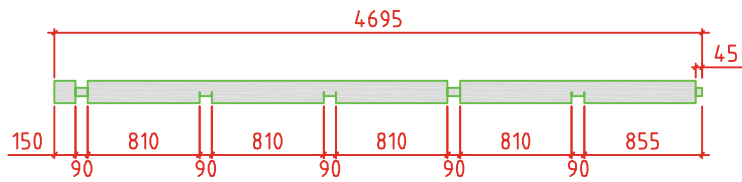

028 /1

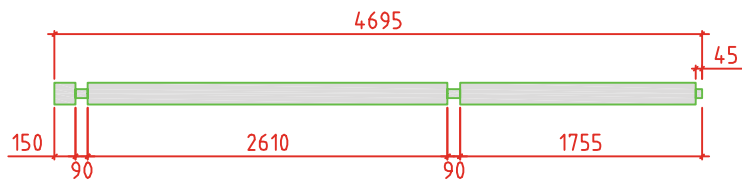

029 /1

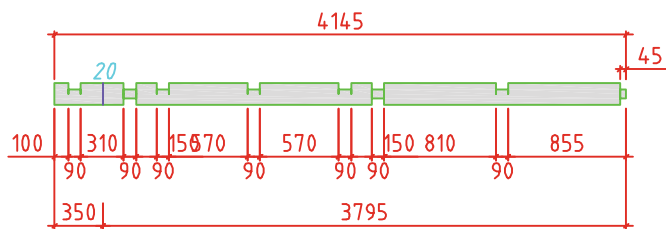

030 /1

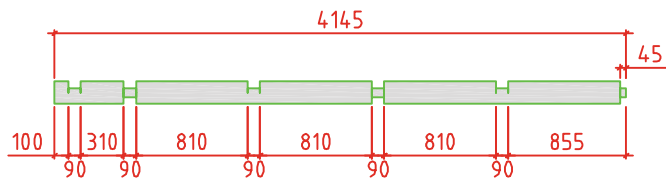

031 /1

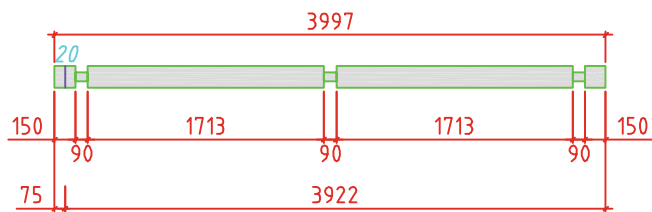

032 /15

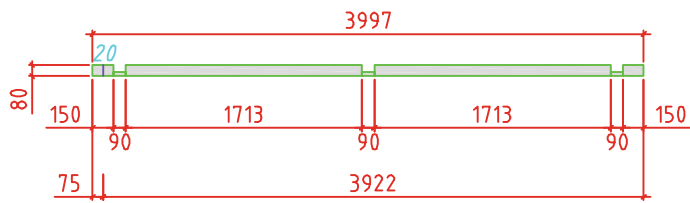

033 /1

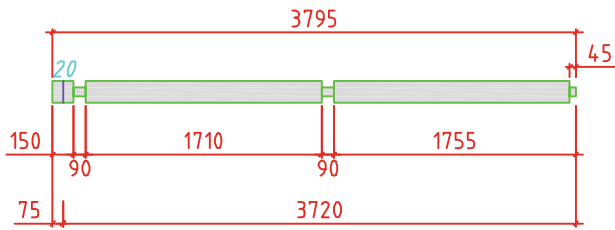

034 /2

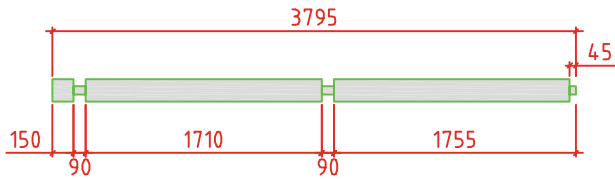

035 /3

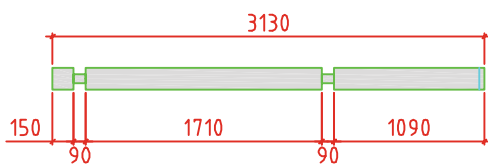

036 /4

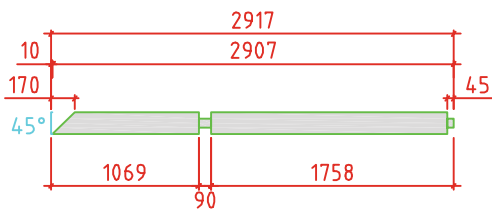

037 /2
To cut of a thorn

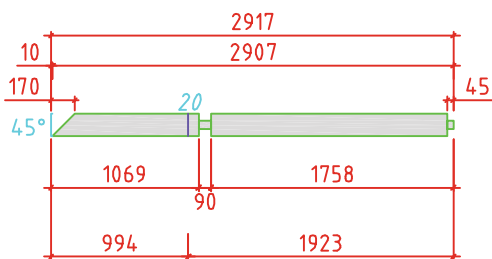

038 /1
To cut of a thorn

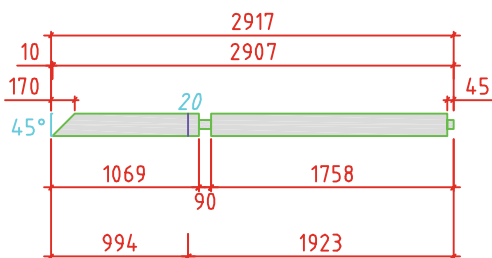

039 /2

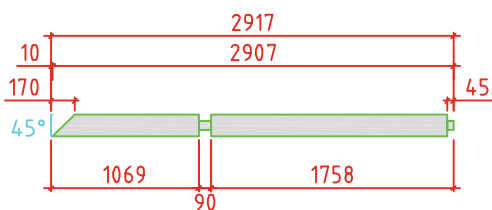

040 /7
To cut of a thorn

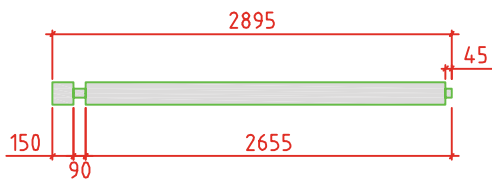

041 / 2

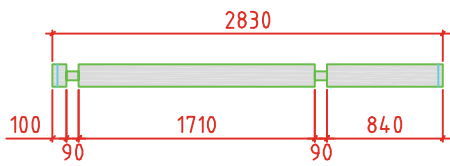

042 / 6

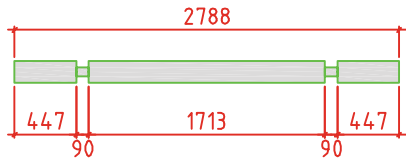

043 / 2

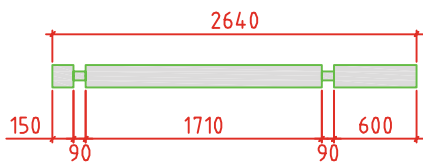

044 / 1

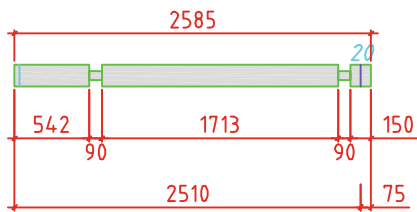

045 / 12

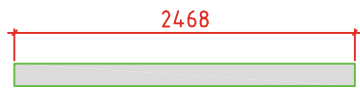

046 / 2

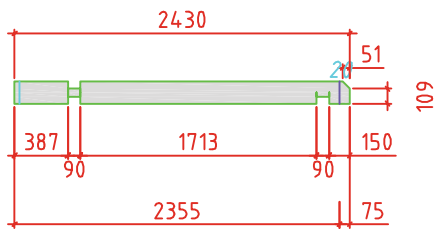

047 / 2

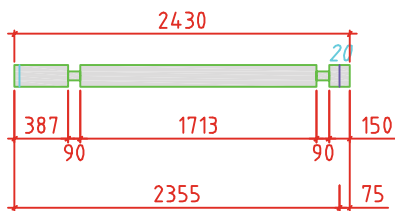

048 / 14

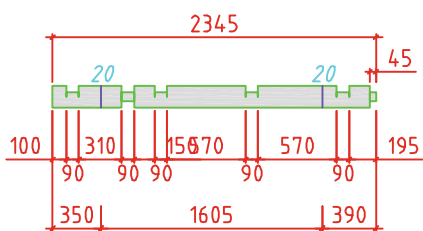

049 / 2

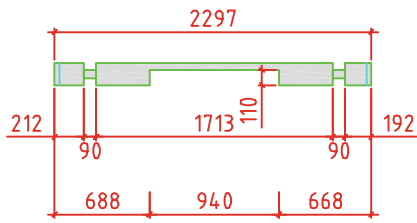

050 /1

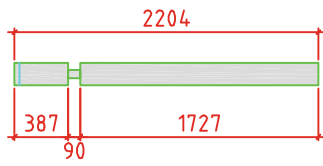

051 /2

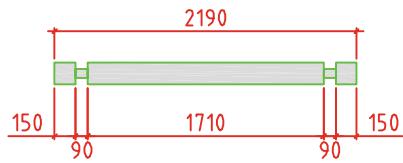

052 /1

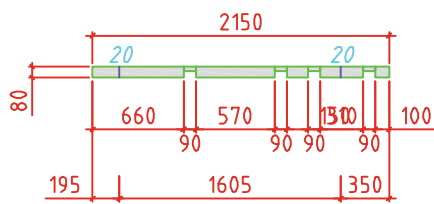

053 /2

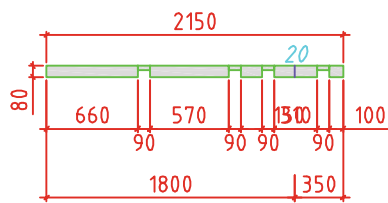

054 /2

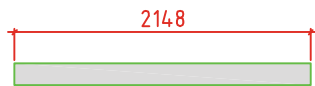

055 /2

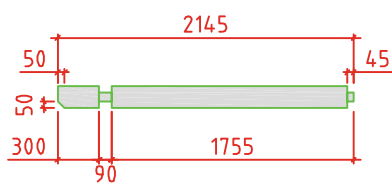

056 /3

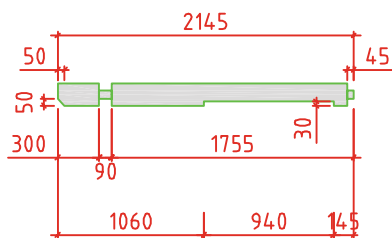

057 /1

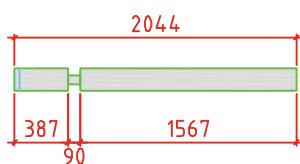

058 /2

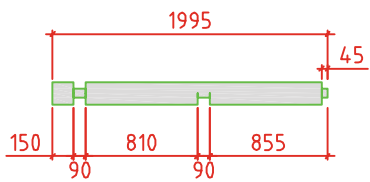

059 /2

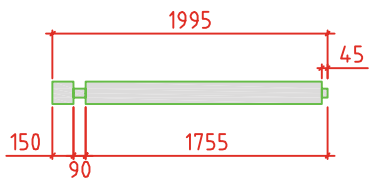

060 /6

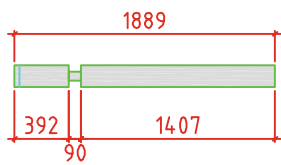

061 /2

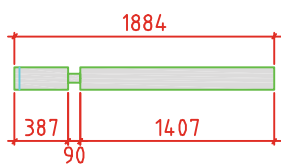

062 /2



063 /2

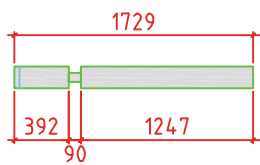

064 /2

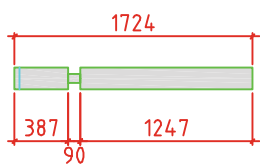

065 /2

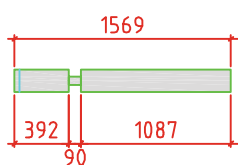

066 /2

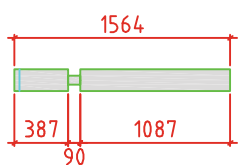

067 /2

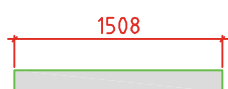

068 /2

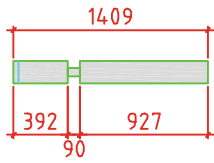

069 /2

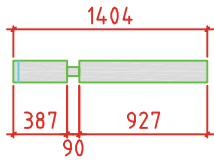

070 /2

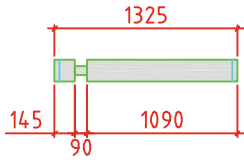

071 /6

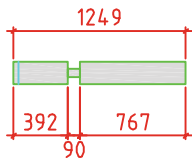

072 /2

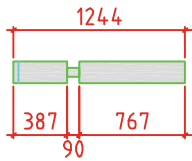

073 /2

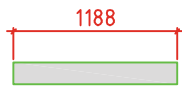

074 /2

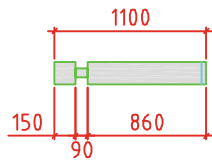

075 /26

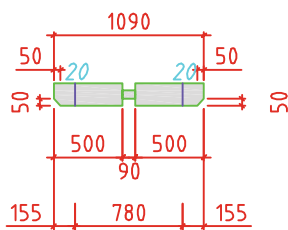

076 /2

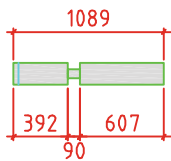

077 /2

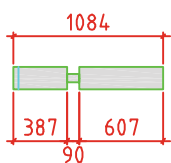

078 /2

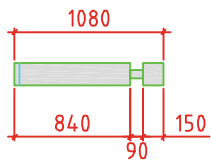

079 /6

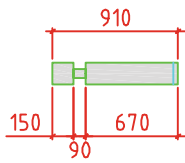

080 /13

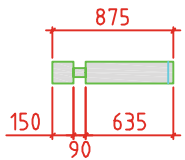

081 /6



082 /2

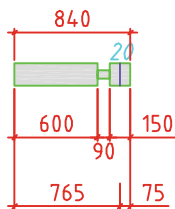

083 /15

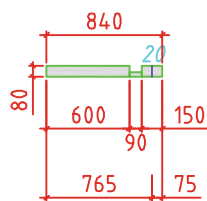

084 /1

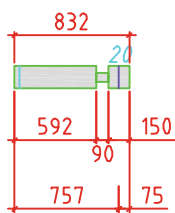

085 /10

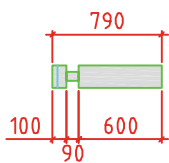

086 /13

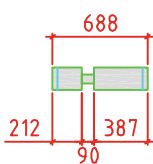

087 /9

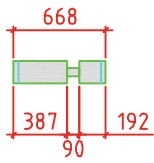

088 /9



089 /2

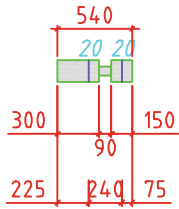

090 /2

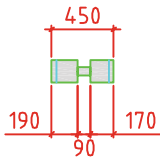

091 /10

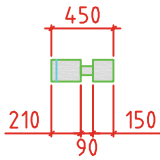

092 /10

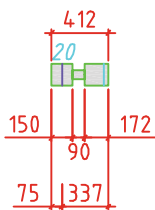

093 /10

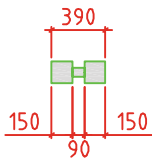

094 /82

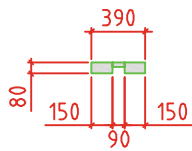

095 /4

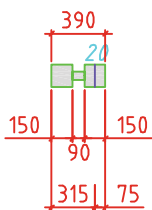

096 /45

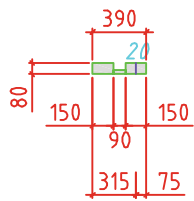

097 / 2

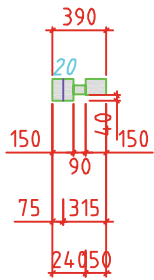

098 / 3

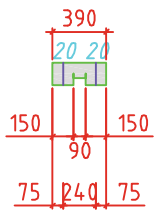

099 / 2

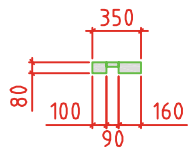

100 / 4

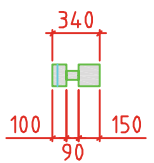

101 / 13



102 / 2

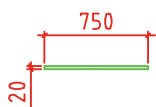

103 / 2

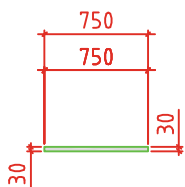

104 / 2

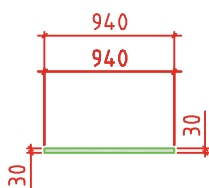

105 / 1

Ground frame



GF4 /2
140x70



GF6 /2
140x70



GF3 /2
140x70



GF7 /2
140x70



GF5 /2
140x70



GF1 /2
90x70



GF2 /2
90x70

RAFTER-1

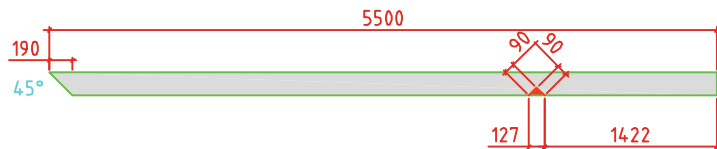

R-11 /28
45x190

Collar beams

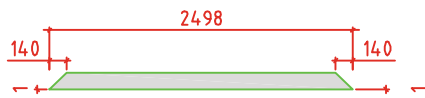

Cb1 /18
45x140

FLOOR JOIST



FJ3 /6
45x190



FJ2 /6
45x190

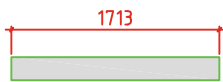

FJ1 /12
45x190



FJ6 /3
45x140

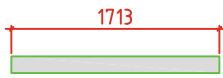

FJ5 /1
45x140

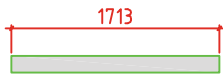

FJ4 /2
45x140

Board for insulation



1 /24
19x120

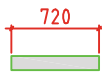

2 /4
19x120

Batten for black floor



2 /6
28x28



1 /6
28x28

Batten for floor board first floor



1 /5
45x45

Batten for ceiling for sauna



1 /4
45x45

Remote lath-1



61 /12
45x45

Fixing slat for roof undercovering



61 /16
90x45

Supporting post

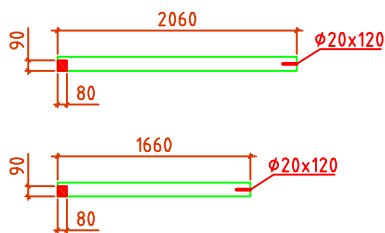

2 /2
120x120

1 /2
120x120

Tender for door and window



T.5 /10
19x90



T.3 /8
19x90

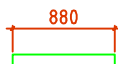

T.2 /8
19x90



T.6 /10
19x25



T.4 /8
19x25



T.1 /8
19x25

| | | | | | |
|-----|-------|--|----|-------|------|
| P1 | Pruss | | 1 | 90x43 | 5320 |
| P2 | Pruss | | 1 | 90x43 | 5006 |
| P3 | Pruss | | 4 | 90x43 | 2150 |
| P4 | Pruss | | 2 | 90x43 | 1014 |
| P5 | Pruss | | 2 | 90x43 | 900 |
| P6 | Pruss | | 10 | 90x43 | 634 |
| P7 | Pruss | | 4 | 90x43 | 350 |
| P8 | Pruss | | 4 | 90x43 | 247 |
| P9 | Pruss | | 4 | 43x43 | 1716 |
| P10 | Pruss | | 2 | 43x43 | 1584 |
| P11 | Pruss | | 8 | 43x43 | 1010 |
| P12 | Pruss | | 2 | 43x43 | 272 |
| L1 | Laud | | 27 | 19x90 | 1014 |
| L2 | Laud | | 20 | 19x90 | 634 |

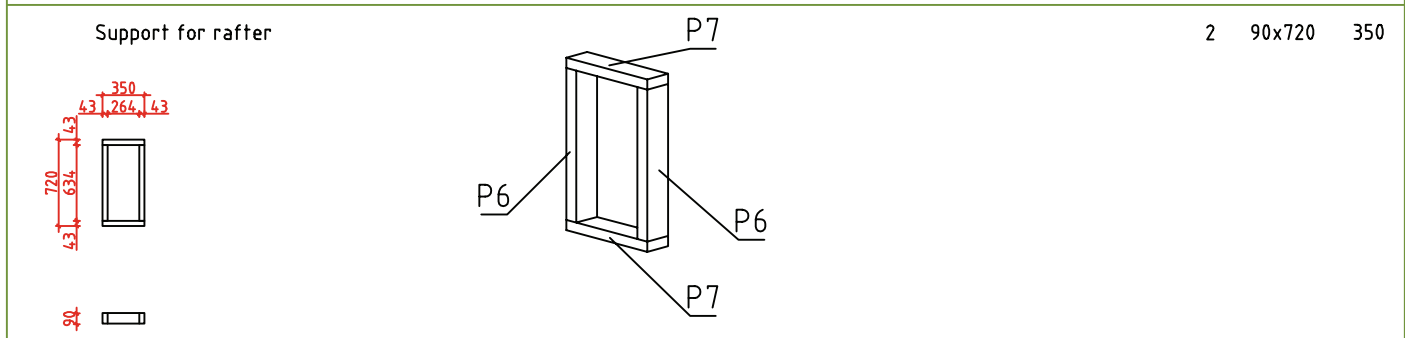
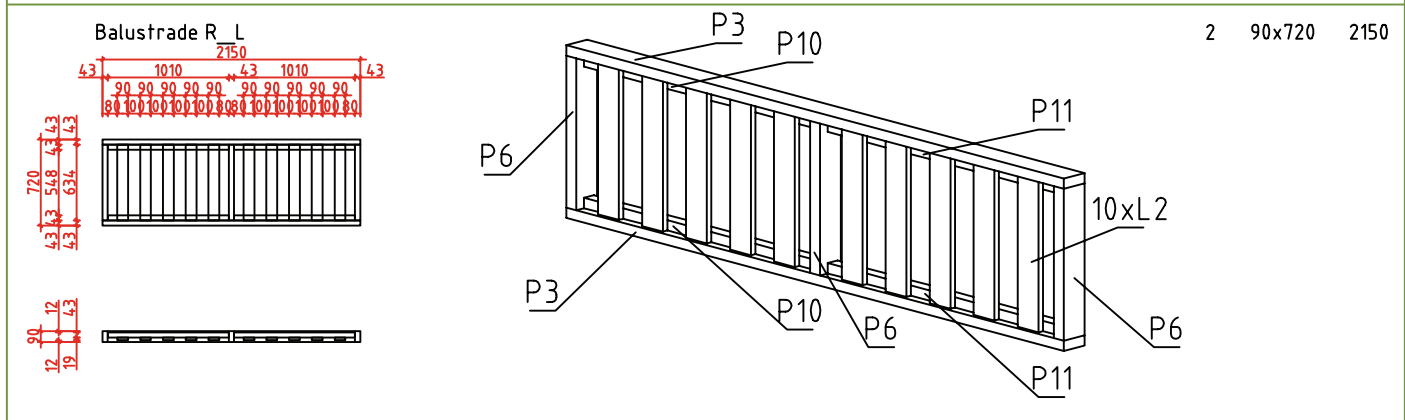
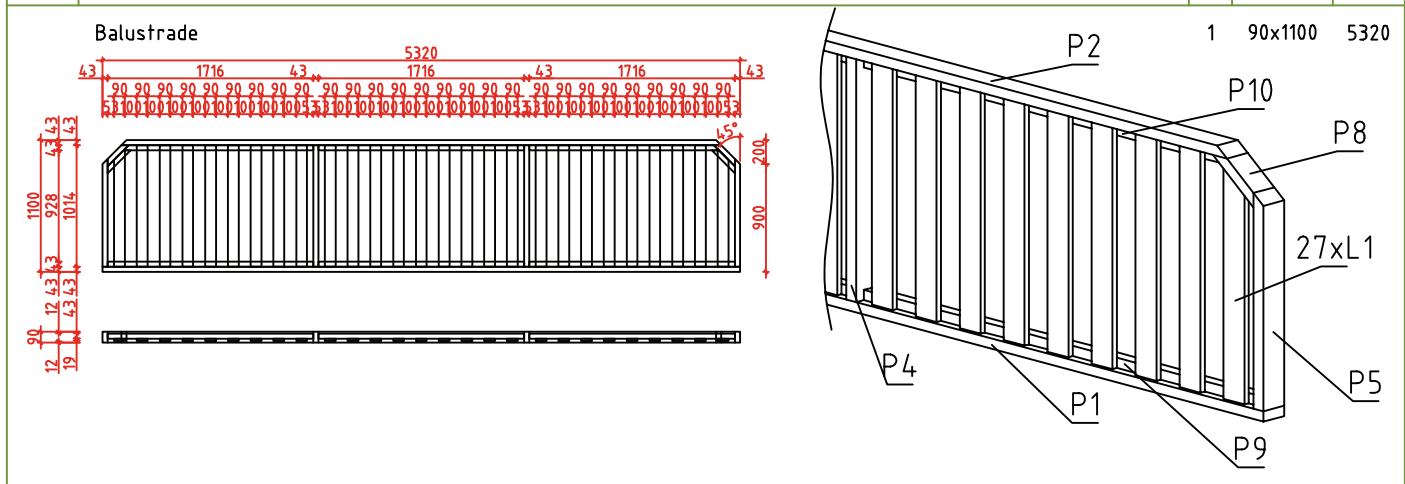

| | | | | | |
|-----|-------|---|----|-------|------|
| P1 | Pruss |  | 1 | 90x43 | 1653 |
| P2 | Pruss |  | 1 | 90x43 | 1496 |
| P3 | Pruss |  | 2 | 90x43 | 900 |
| P4 | Pruss |  | 3 | 90x43 | 814 |
| P5 | Pruss |  | 1 | 90x43 | 700 |
| P6 | Pruss |  | 1 | 90x43 | 247 |
| P7 | Pruss |  | 1 | 43x43 | 1567 |
| P8 | Pruss |  | 1 | 43x43 | 1435 |
| P9 | Pruss |  | 2 | 43x43 | 814 |
| P10 | Pruss |  | 1 | 43x43 | 272 |
| L1 | Laud |  | 12 | 19x90 | 814 |

Balustrade for stairs

1 90x900 1653

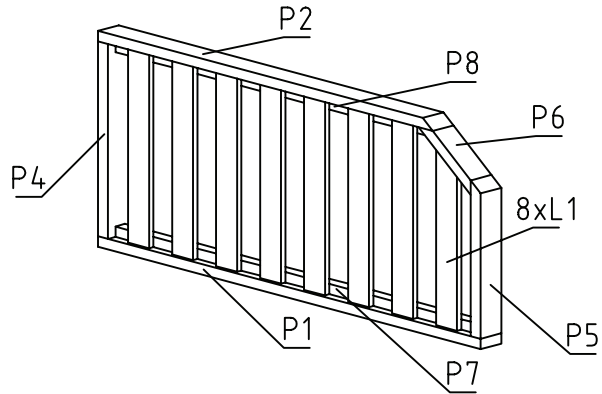
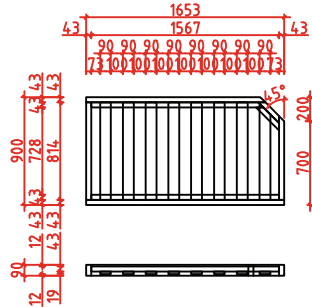

Balustrade for stairs

1 90x900 900

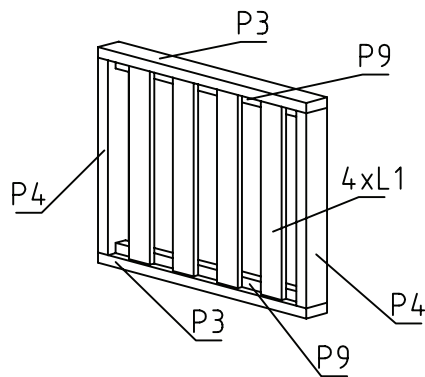
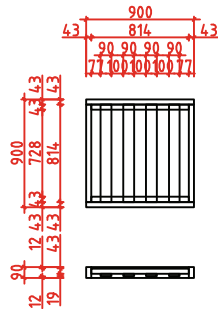

Floor board.Ground floor 114x28/88x28



4455 mm
4405 mm
1755 mm
1705 mm

9 pcs. /12 pcs.
47 pcs. /61 pcs.
9 pcs. /12 pcs.
36 pcs. /47 pcs.

Floor board.First floor 114x28/88x28



4500 mm
4455 mm
1755 mm

16 pcs. /21 pcs.
32 pcs. /42 pcs.
32 pcs. /42 pcs.

Terrace board Terrace board 114x28



1800 mm
1710 mm

43 pcs.
4 pcs.

Balcony board Balcony board 114x28



1800 mm

47 pcs.

Black floor E type 90x19



1653 mm
1623 mm

68 pcs.
136 pcs.

Remote lath Remote lath 45x70



3623 mm
3488 mm
3488 mm

10 pcs.
5 pcs.
5 pcs.

Roof board 11.4x1.9/ Roof board 88x19



| | |
|---------|------------------|
| 4980 mm | 49 pcs. /64 pcs. |
| 4210 mm | 49 pcs. /64 pcs. |
| 3605 mm | 49 pcs. /64 pcs. |
| 3175 mm | 49 pcs. /64 pcs. |
| 2410 mm | 49 pcs. /64 pcs. |

Ceiling board 8.8x1.2 STVO Ceiling board STVO 88x12



| | |
|---------|----------|
| 2515 mm | 142 pcs. |
| 3440 mm | 11 pcs. |
| 2540 mm | 11 pcs. |
| 2770 mm | 11 pcs. |
| 1800 mm | 11 pcs. |
| 1865 mm | 11 pcs. |

CEILING for sauna Ceiling board STVO 88x12



| | |
|---------|---------|
| 1705 mm | 40 pcs. |
|---------|---------|

Baseboard 19x35 19x35



127.94 run.m.

Roof decor 1.9x12 19x120



| | |
|---------|--------------|
| Total | 82.29 run.m. |
| 2355 mm | 2 pcs. |
| 3120 mm | 2 pcs. |
| 3605 mm | 2 pcs. |
| 4157 mm | 2 pcs. |
| 4923 mm | 2 pcs. |
| 5747 mm | 8 pcs. |

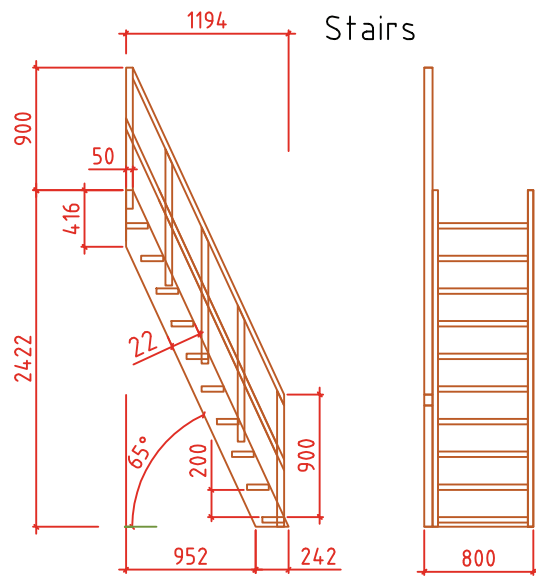

Stairs

1 pc.



Fixing corner 90x90x65

Total

80 pcs.



Fixing plate 100x150

Total

28 pcs.



SUPPORT M20

Total

4 pcs.



M10x 3650

4 ps.

M10x 3330

4 ps.

M10x 610

8 ps.

M10x 530

2 ps.

M10x 450

4 ps.



M12

22 ps.



M12

x22 ps.



M12

8 ps.